

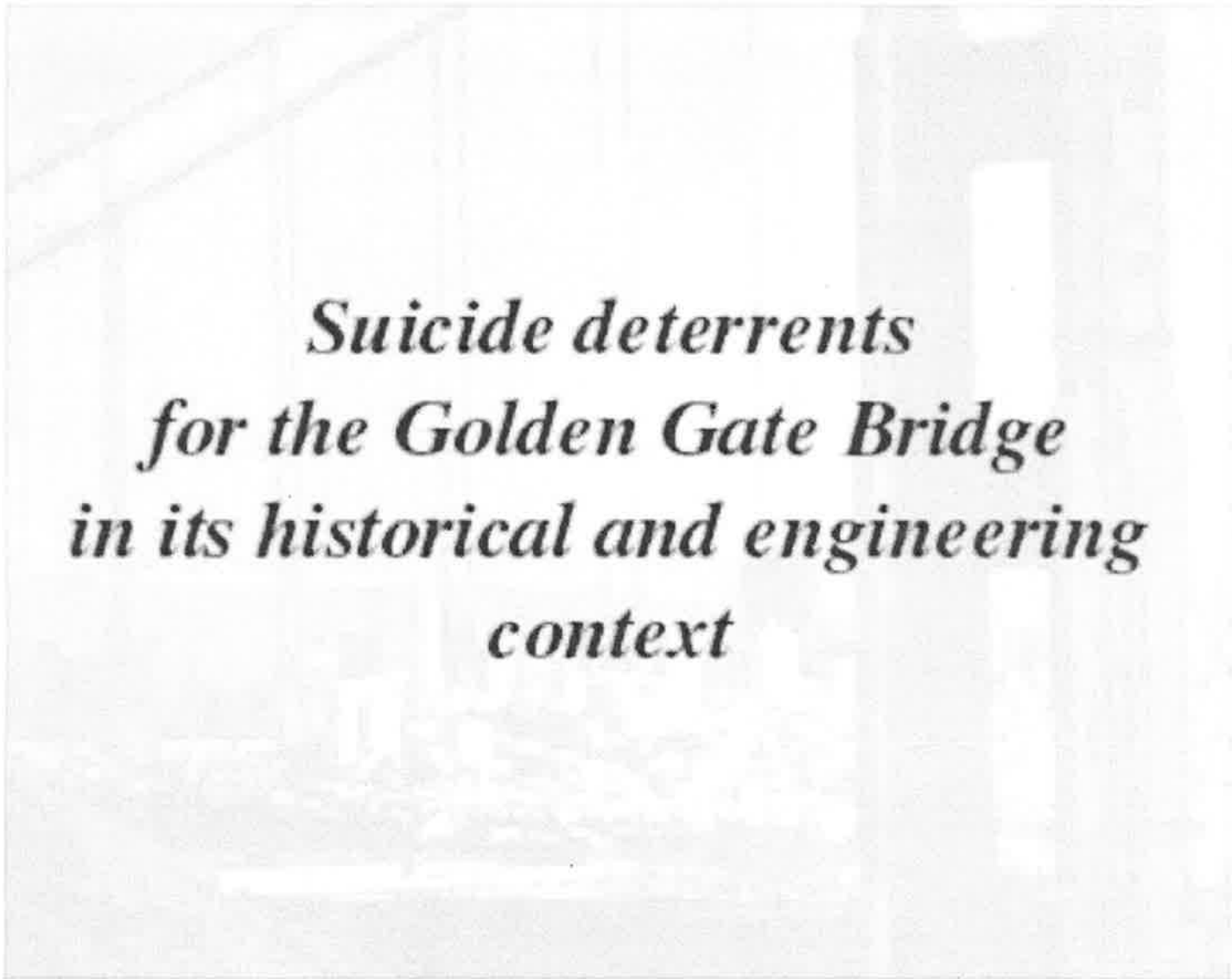

*Golden Gate Bridge  
Suicide Prevention Review*

*March 1999*



*Suicide deterrents  
for the Golden Gate Bridge  
in its historical and engineering  
context*

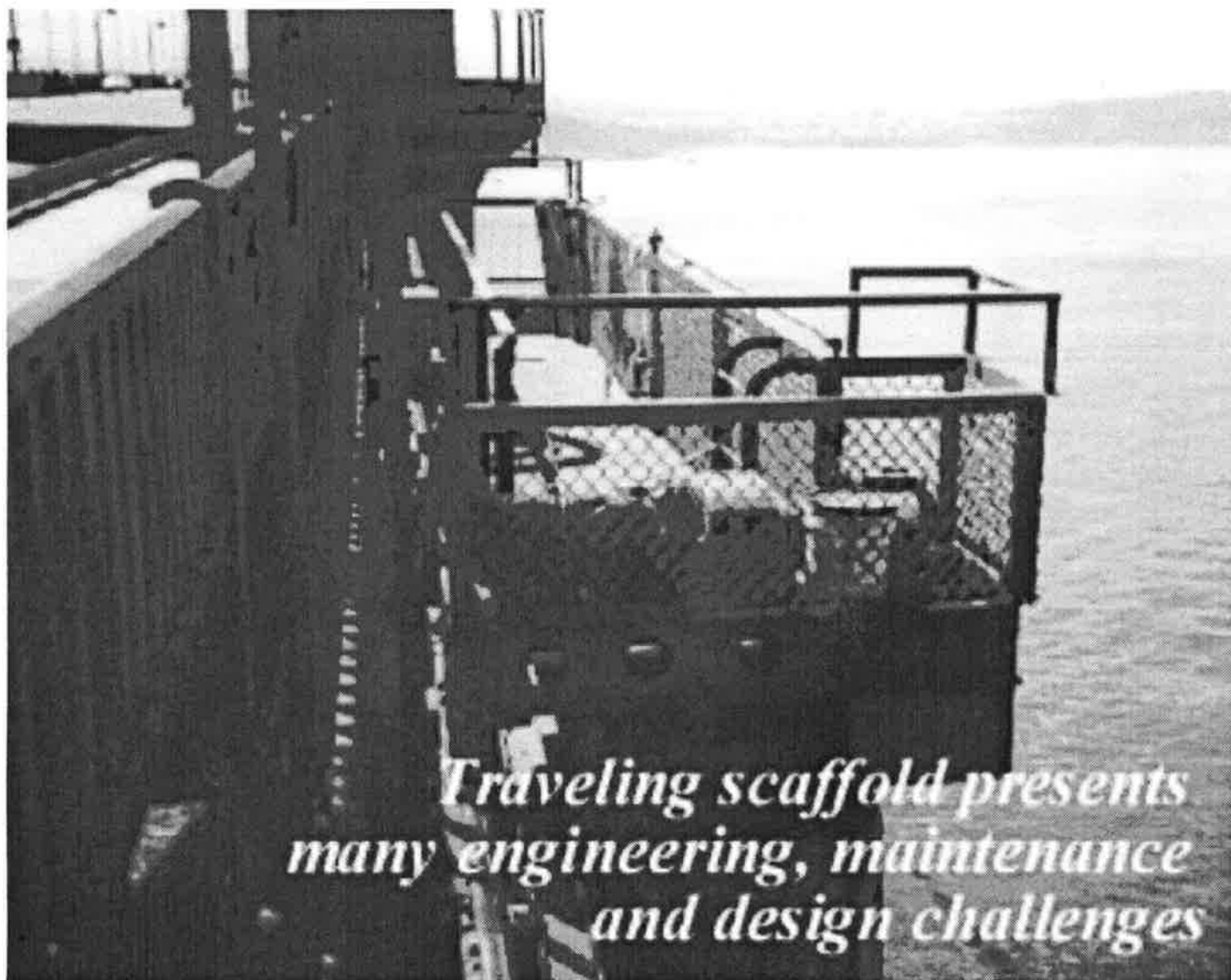



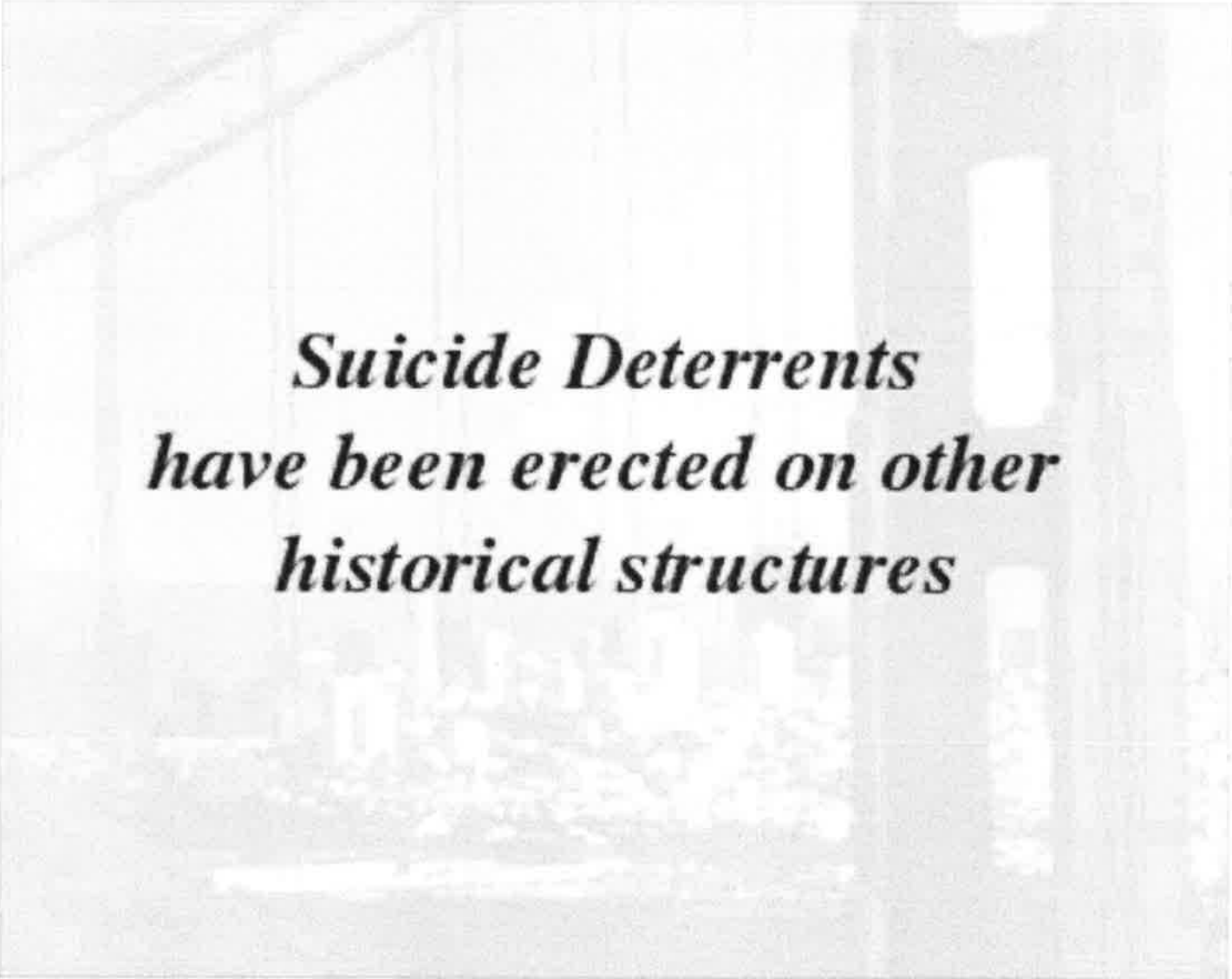

*Suicide Deterrents  
have been erected on other  
historical structures*

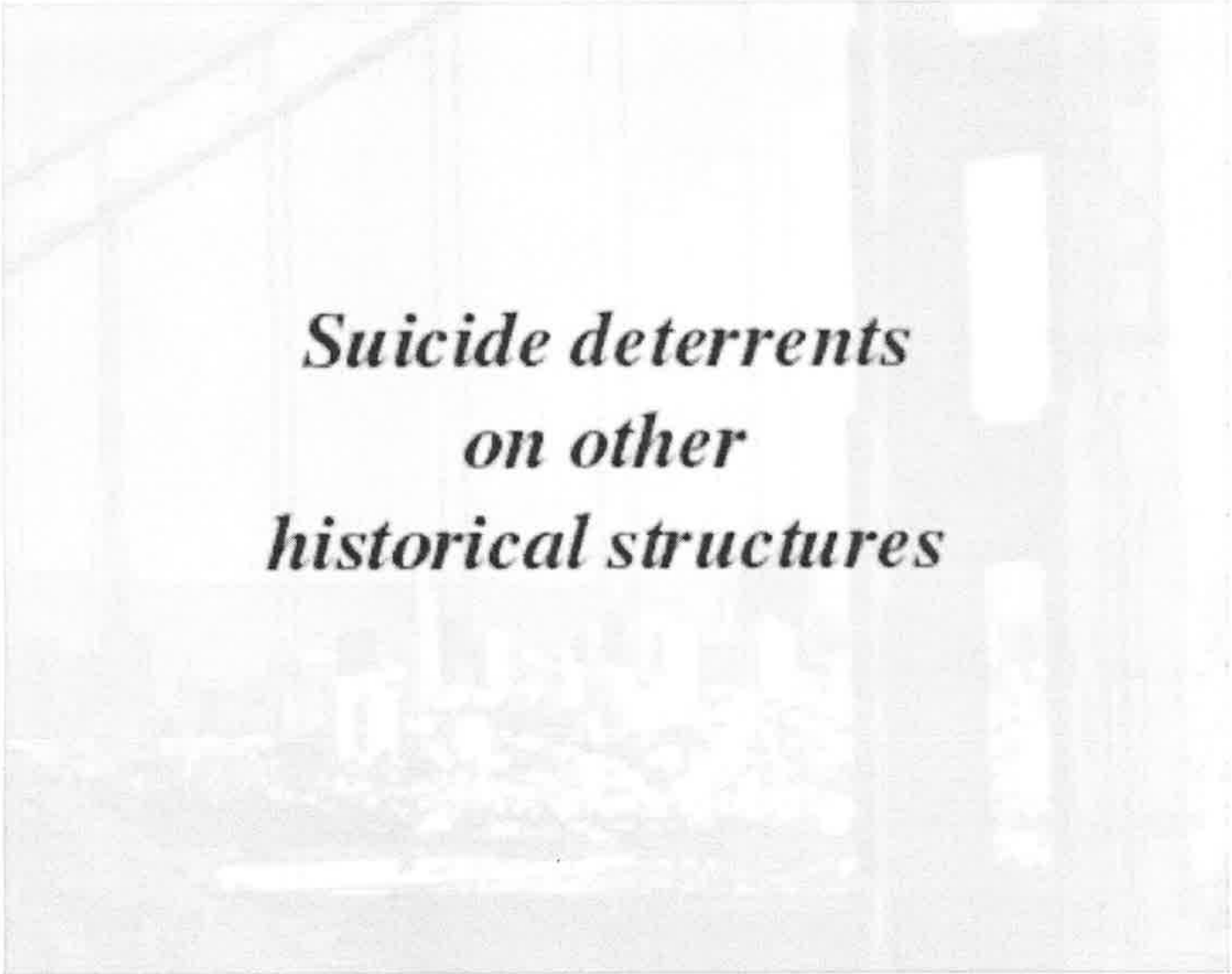

*Suicide deterrents  
on other  
historical structures*



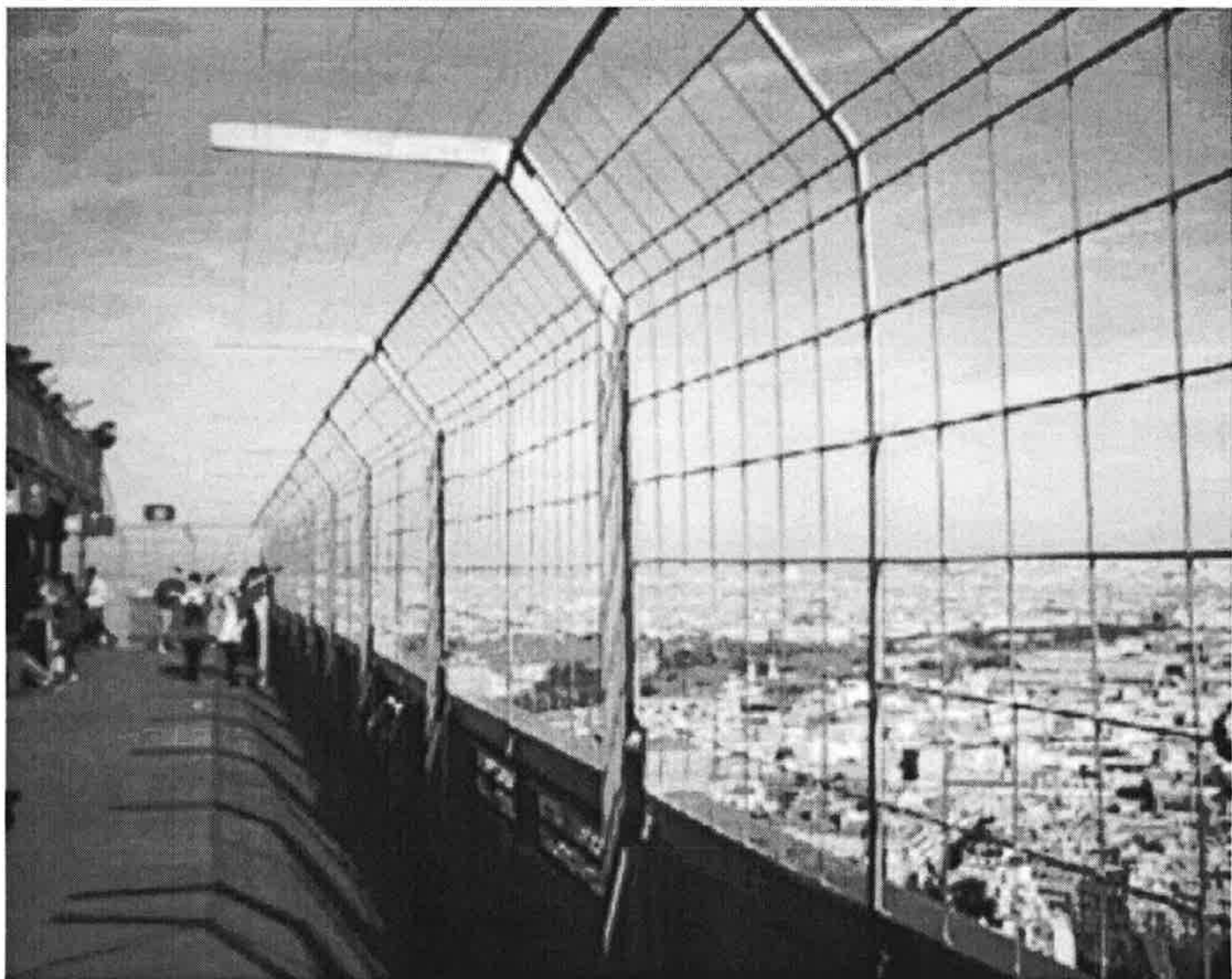





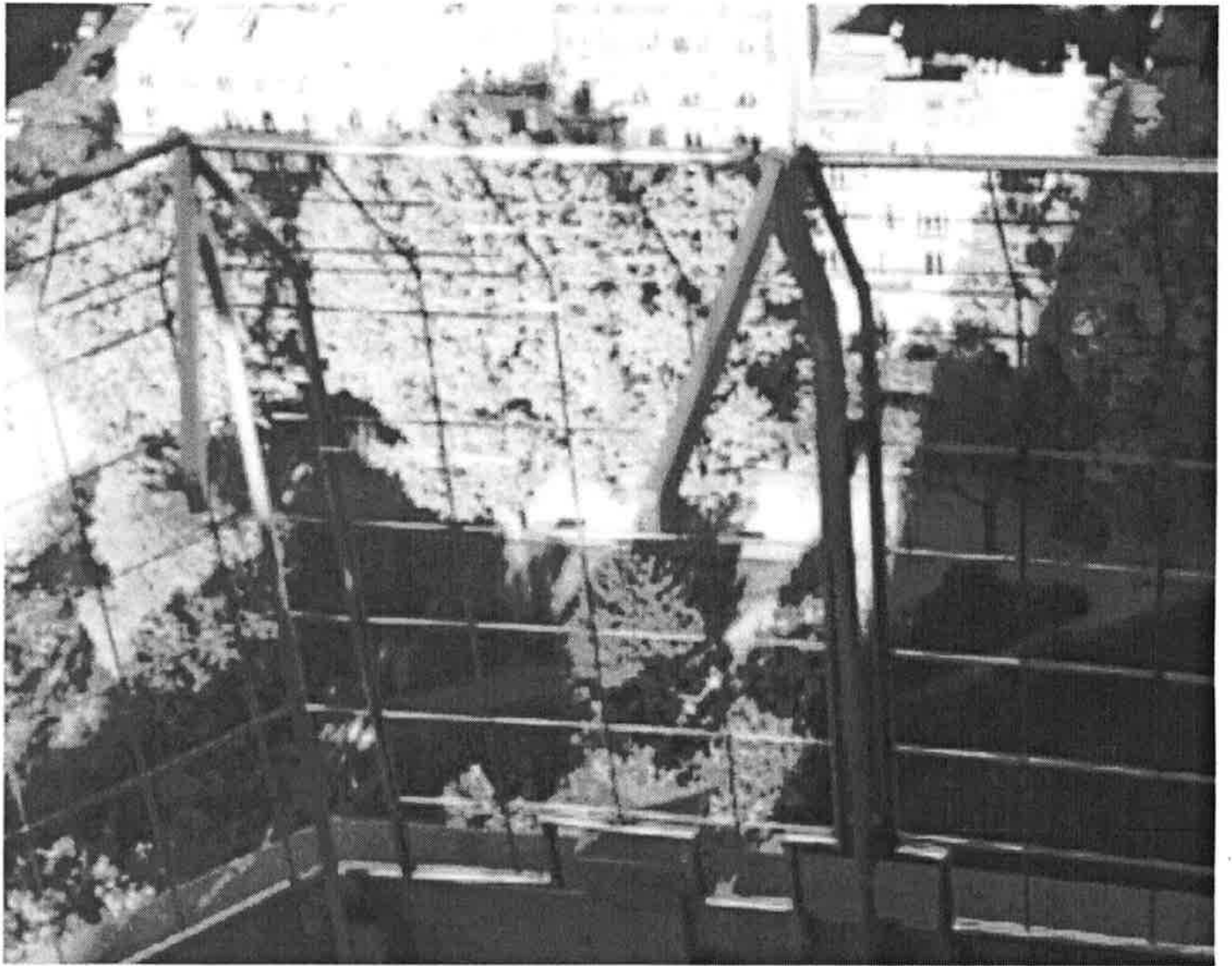

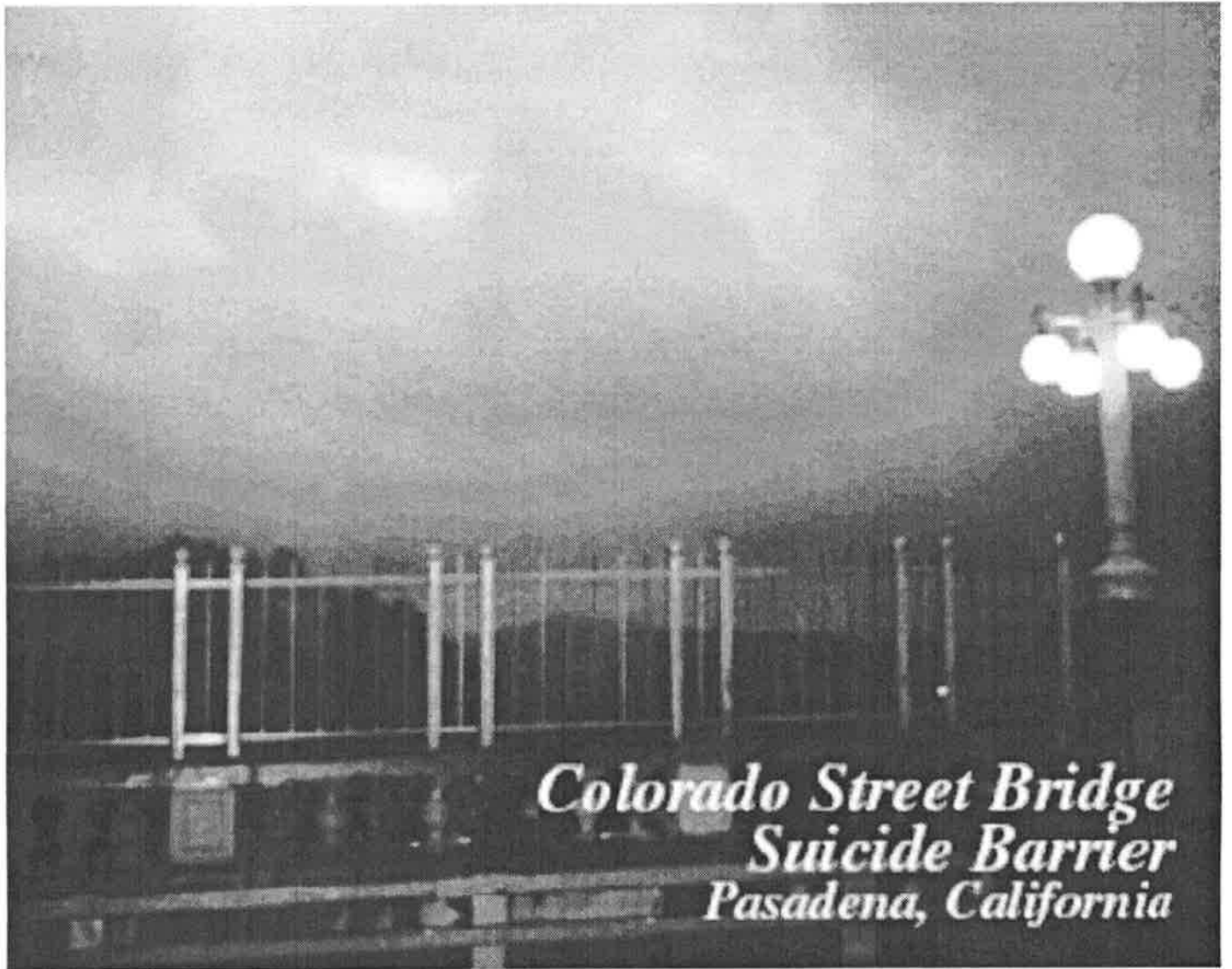

*Colorado Street Bridge  
Suicide Barrier  
Pasadena, California*





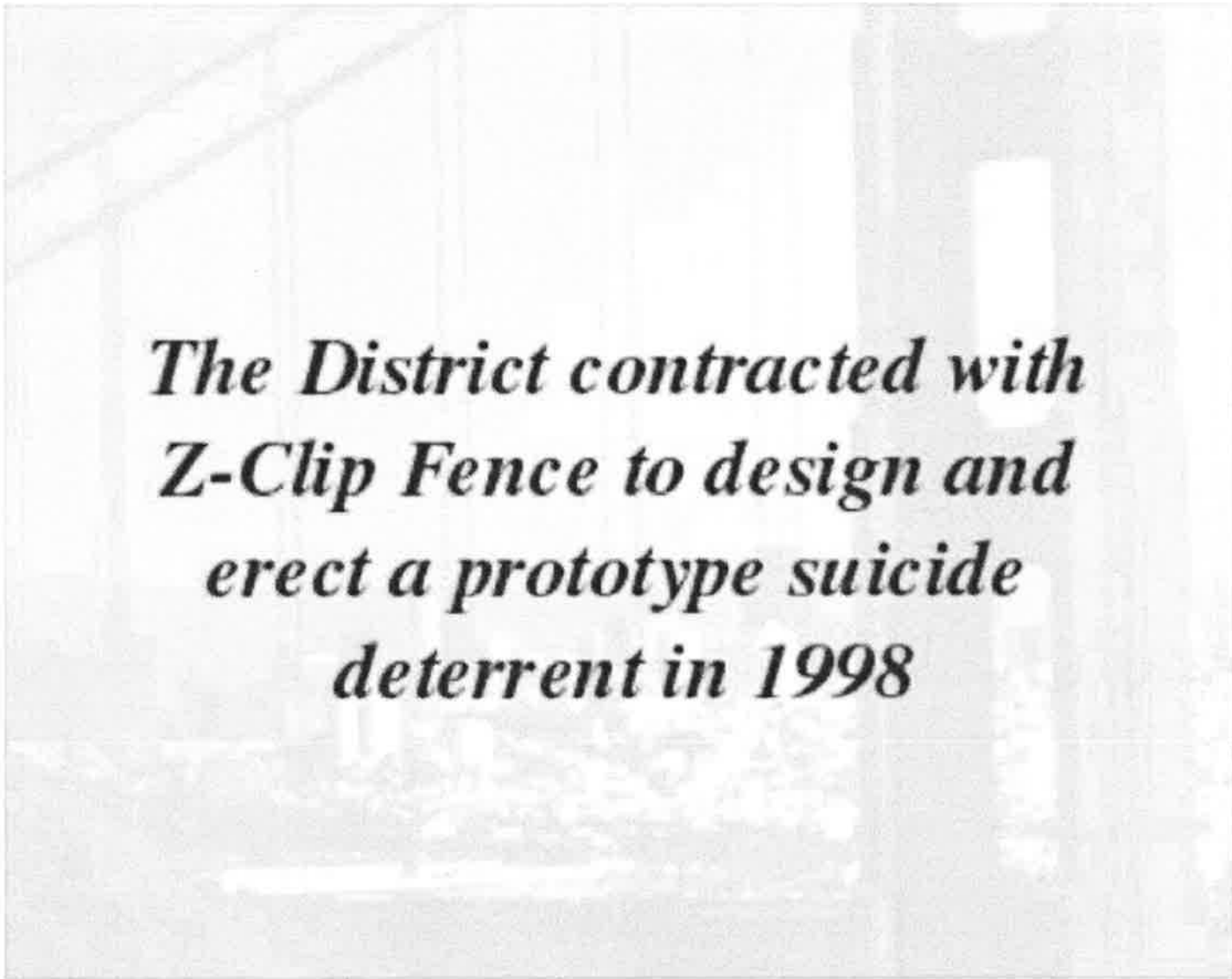

*The District contracted with  
Z-Clip Fence to design and  
erect a prototype suicide  
deterrent in 1998*

*Z-Clip Prototype Fence*

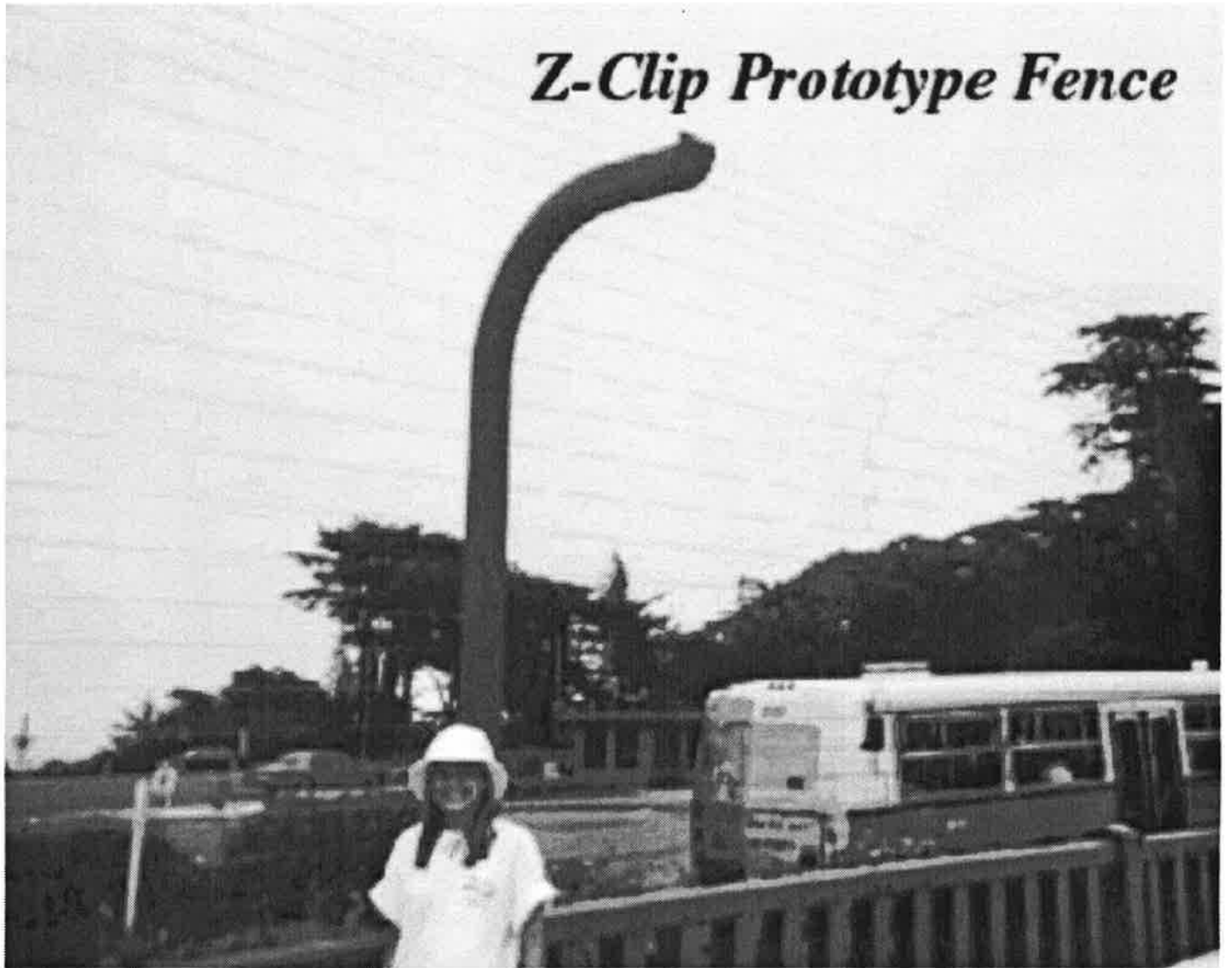

*Z-Clip Prototype  
Fence*

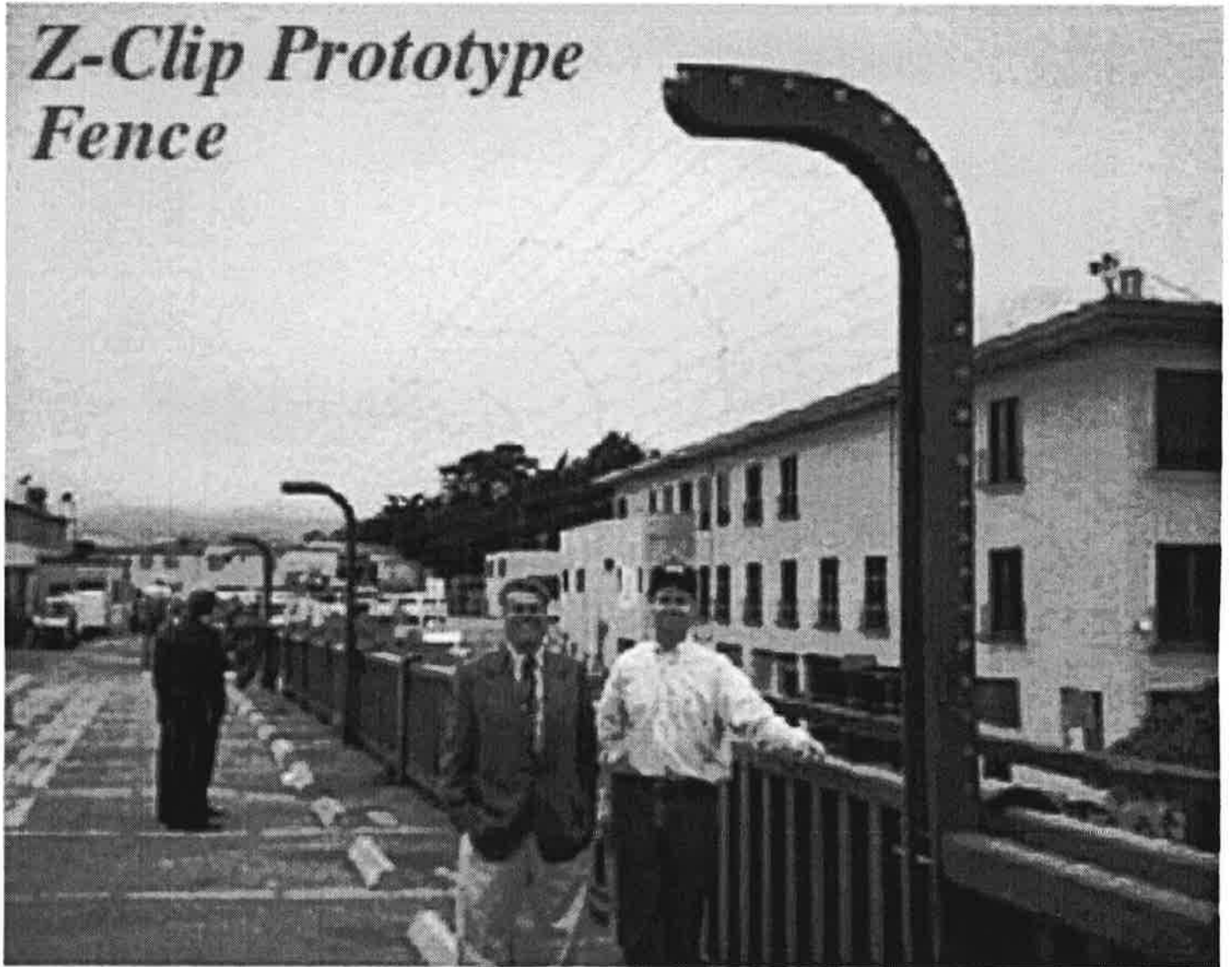





*The Z-Clip Fence  
was extremely difficult  
to climb over*







## *Z-Clip Prototype Fence*



### *Conclusion:*

*Architecture Review Panel felt post complimented lightoliers on the Bridge*

*Panel did not favorably support the wire fence design*

### *Summary:*

*Presumably effective deterrent*

*Criteria was established  
for the Golden Gate Bridge  
Suicide Deterrent by this  
important document  
dated 1971*

## **GOLDEN GATE BRIDGE**

**SUICIDE PREVENTION STUDY (PHASE I)  
REPORT ON THE CONCEPT**

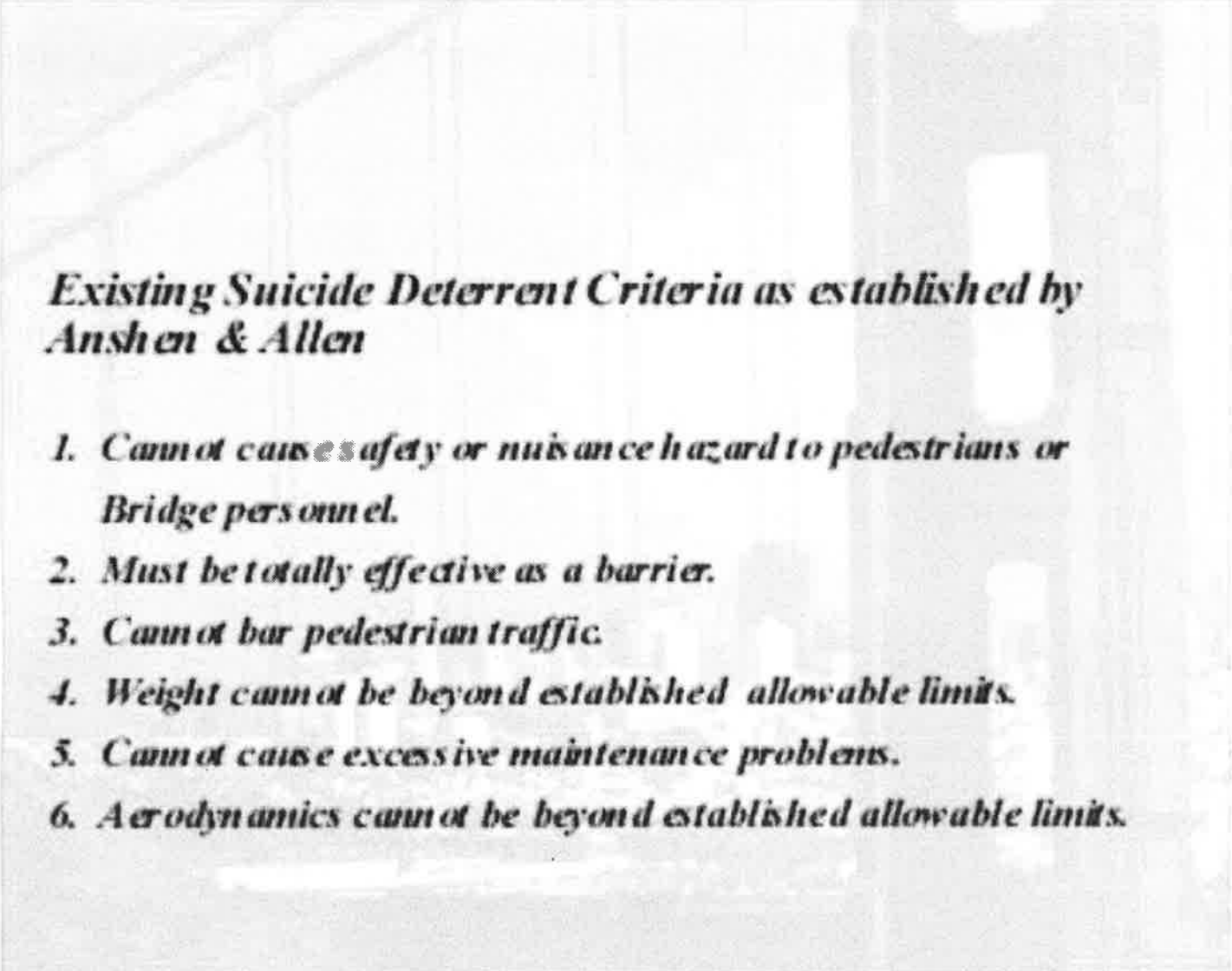

***Existing Suicide Deterrent Criteria as established by Anshen & Allen***

- 1. Cannot cause safety or nuisance hazard to pedestrians or Bridge personnel.***
- 2. Must be totally effective as a barrier.***
- 3. Cannot bar pedestrian traffic.***
- 4. Weight cannot be beyond established allowable limits.***
- 5. Cannot cause excessive maintenance problems.***
- 6. Aerodynamics cannot be beyond established allowable limits.***

*Note:*  
*Subsequent to*  
*the Anshen & Allen*  
*study, historical preservation*  
*and environmental criteria*  
*must be addressed*



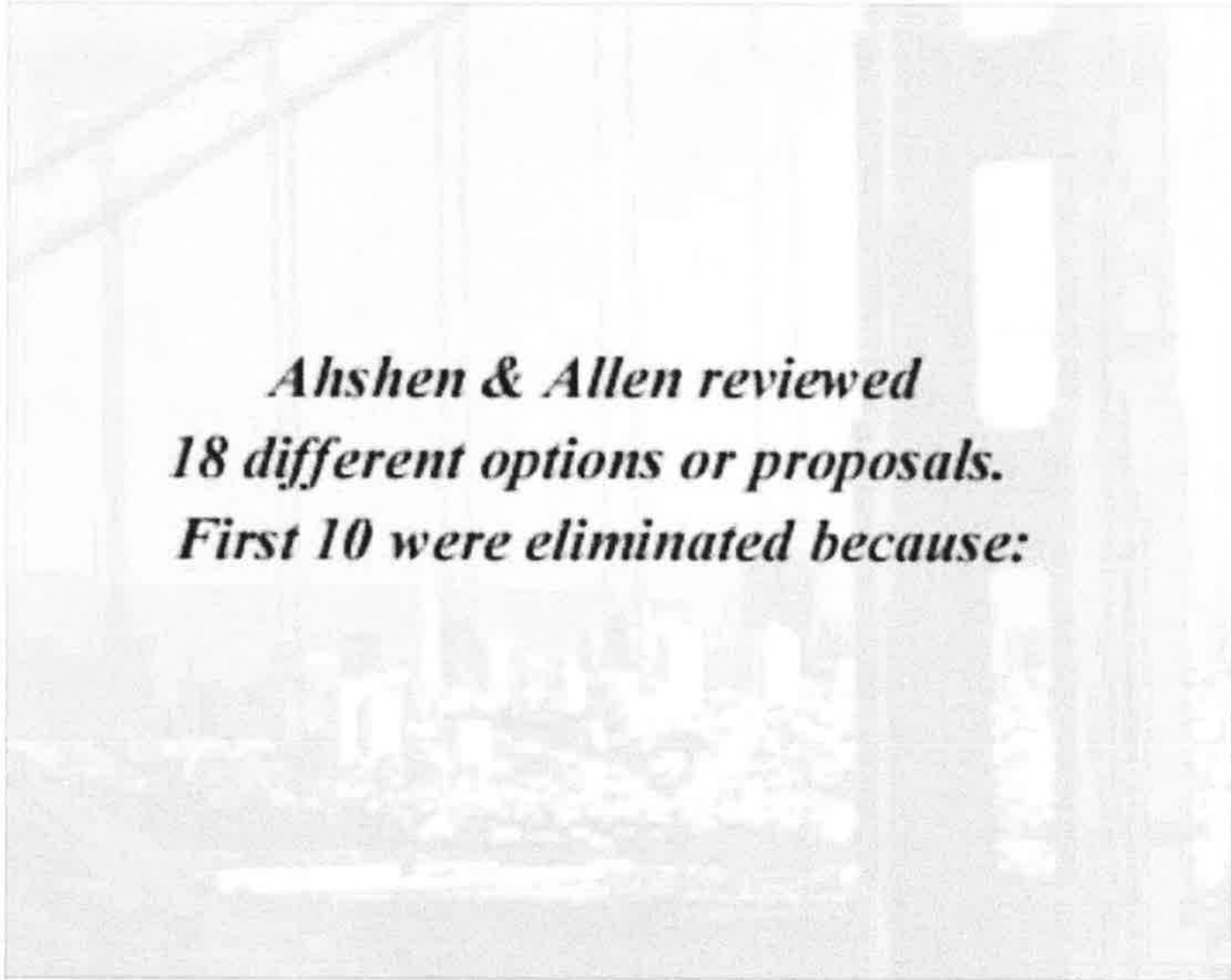

*Ahshen & Allen reviewed  
18 different options or proposals.  
First 10 were eliminated because:*

***1. Barbed Wire fence, 9 feet high:***

*Safety hazard to pedestrians and bridge personnel.*

*Nuisance law suits could be brought against District for injury and torn clothing.*

***2. Square mesh safety net fence above rail:***

*Ineffective because of horizontal member acting as a ladder.*

*Could easily be cut with wire cutters thus creating a maintenance nuisance.*

***3. U-Shaped spikes, 18 inches high  
on top of rail:***

*Ineffective, can be climbed over, spikes act as handles.  
Interfere with pedestrians leaning on rail, creates  
torn clothing.*

***4. Rail bent outward to form 1/4 circle:***

*Ineffective, can be climbed over. Hazardous to pedestrians  
because it would create a feeling of insecurity.*

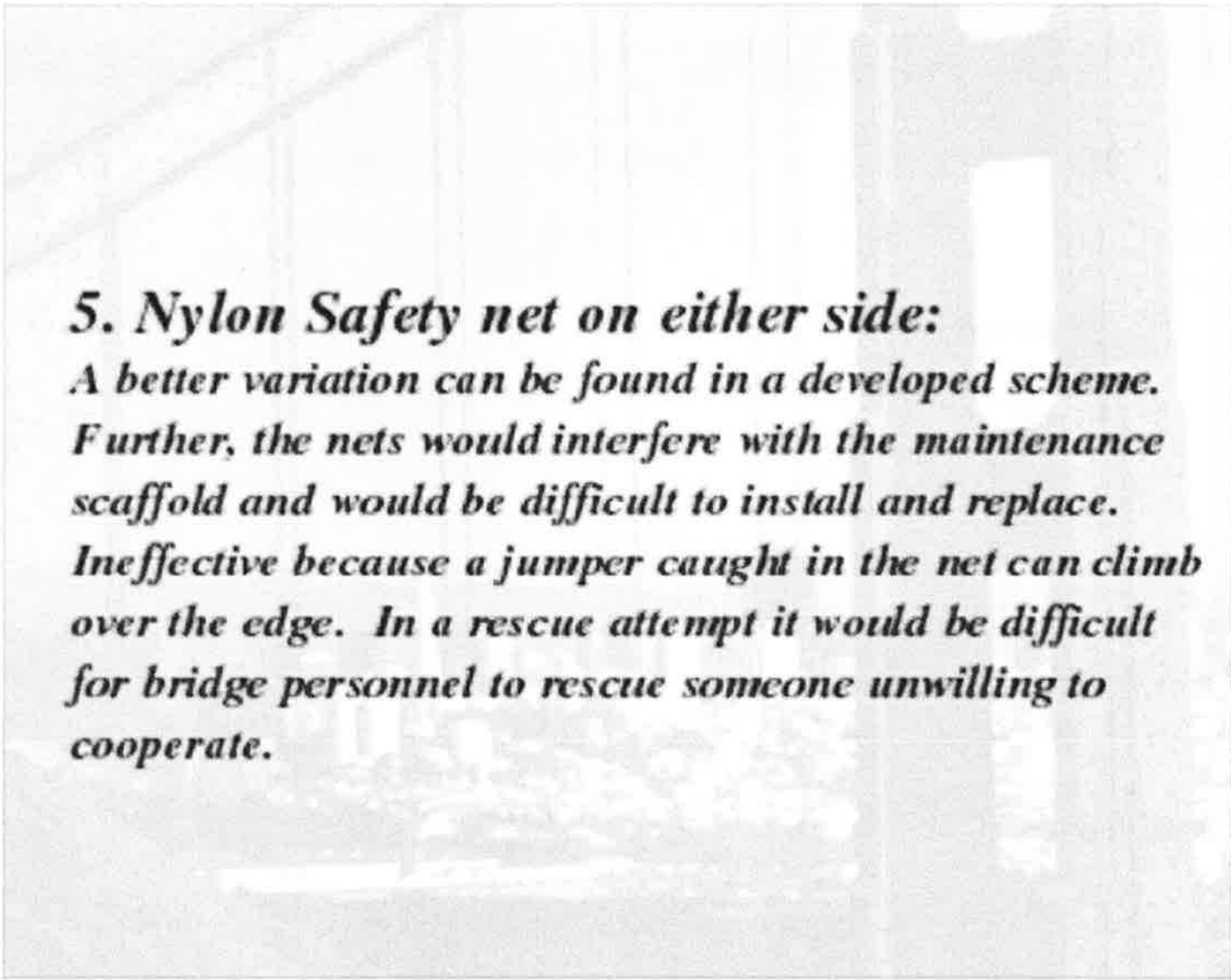

***5. Nylon Safety net on either side:***

*A better variation can be found in a developed scheme. Further, the nets would interfere with the maintenance scaffold and would be difficult to install and replace. Ineffective because a jumper caught in the net can climb over the edge. In a rescue attempt it would be difficult for bridge personnel to rescue someone unwilling to cooperate.*

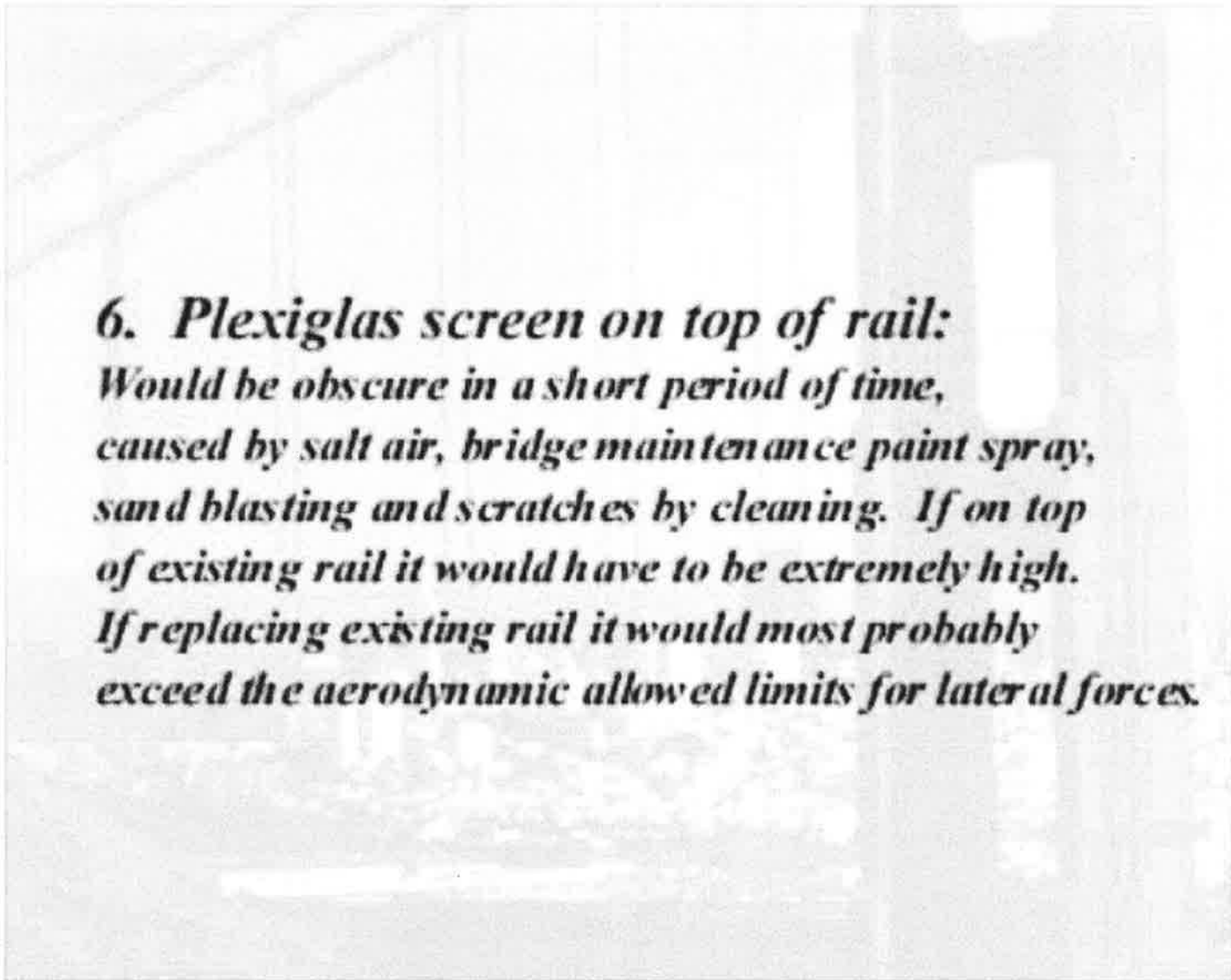

**6. Plexiglas screen on top of rail:**  
*Would be obscure in a short period of time, caused by salt air, bridge maintenance paint spray, sand blasting and scratches by cleaning. If on top of existing rail it would have to be extremely high. If replacing existing rail it would most probably exceed the aerodynamic allowed limits for lateral forces.*

***7. Redesigned rail 7 feet high with Plexiglas balusters:***

*A better variation can be found in a developed scheme; further, most comments on item 6 apply.*

***8. Horizontal tension cables:***

*Ineffective because cable act as a ladder and therefore can easily be climbed on.*

***9. Low voltage electric fence:***

*Hazardous to safety of pedestrians and bridge personnel. Depending on the atmospheric conditions, people could be electrocuted. Nuisance hazard if used for vandalism.*

***10. Laser beam:***

*Low voltage, would only act as a detection device and it is effective as a physical barrier or deterrent.*

*High voltage, can cause severe, possibly fatal burns to pedestrians and personnel. Ineffective as a deterrent.*



*Anshen & Allen selected  
designs that they found  
had merit*



PROPOSAL

13

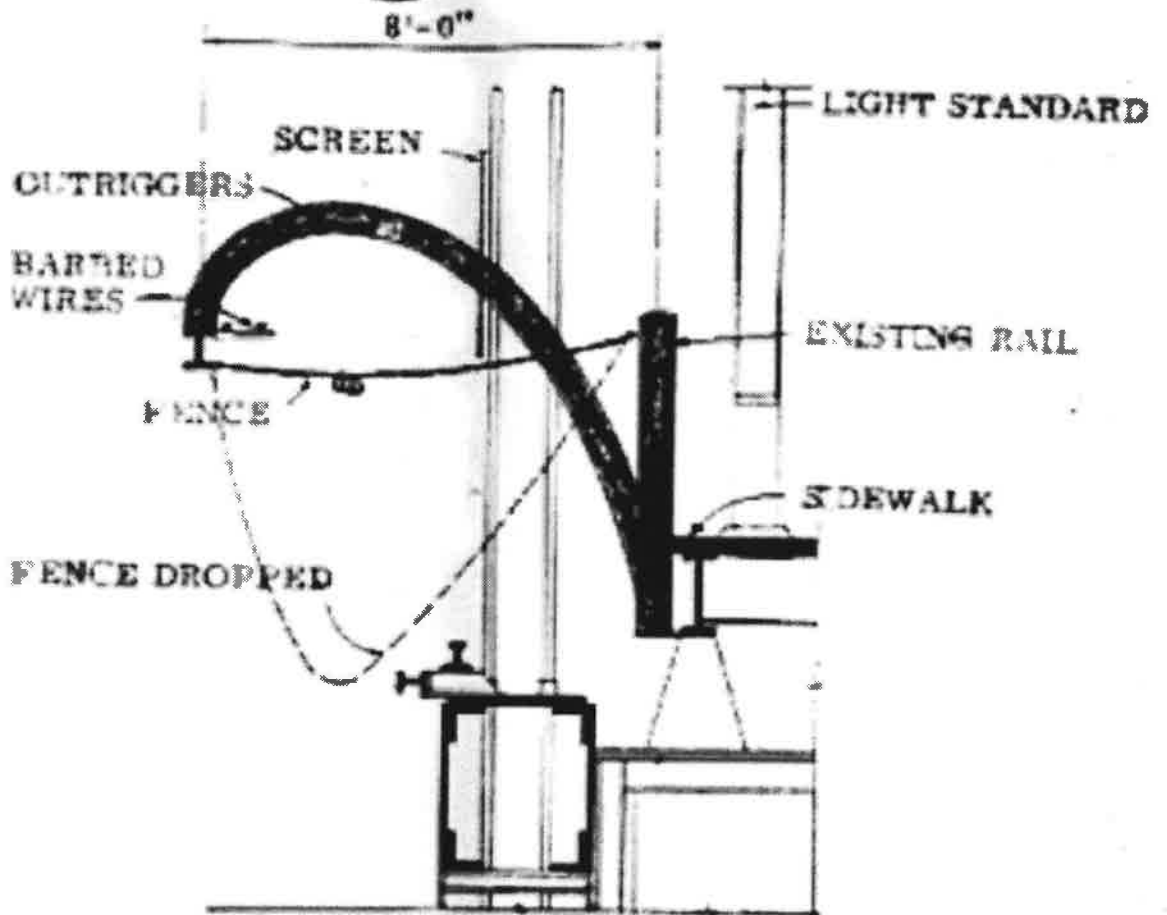

## *14. Rotating Cylinder on top of rail*

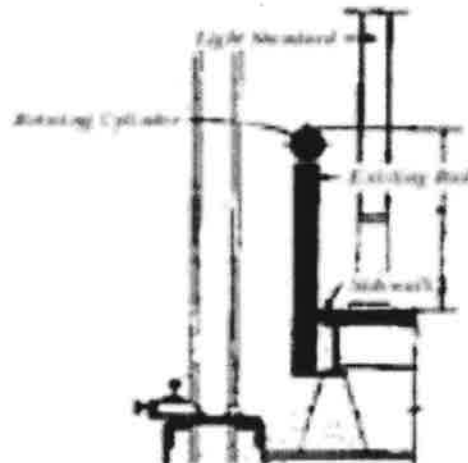

### *Design:*

*Rotating cylinder on top of existing rail to prevent climbing of the rail.*

### *Evaluation:*

*Rail can easily be jumped or scaled by holding on to light standard or suspension cables. Cylinders obscure view and may be hazardous by pinching a finger.*

## *15. Re-designed handrail - top rail widening*

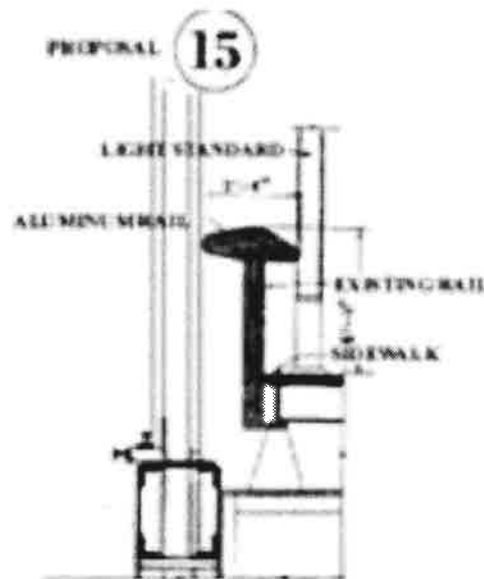

*Design:*

*Top rail raised to 5 feet and widened with steel plate.*

*Evaluation:*

*Ineffective because light standard or suspension cables can be used as an aid for climbing. Top rail impairs view.*

## 18. Aluminum Side Guards with Net

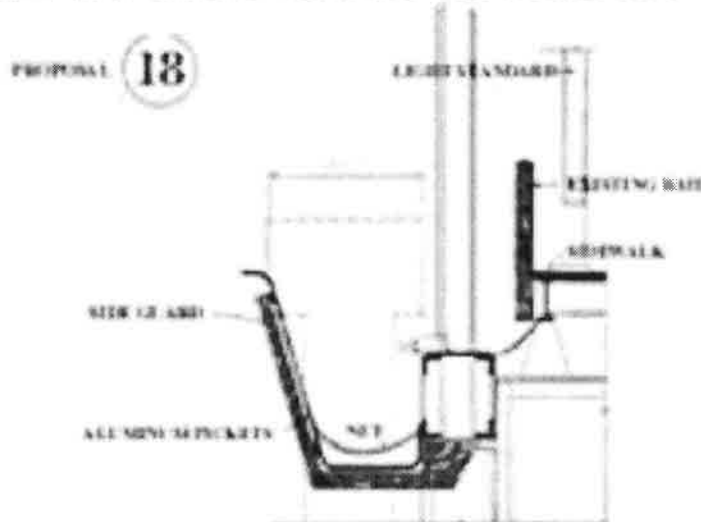

### *Design:*

*Basket type metal side guard constructed wide enough to prevent persons jumping across it.*

### *Evaluation:*

*Prevention and apprehension are positive (subject to test) bridge silhouette maintained. View improved to minor degree. However; wind, maintenance interference with scaffold, emergency response excessive cost, and attractive nuisance issues must be considered.*

## *11. Wrought Iron Fence, Curved Spikes Top*

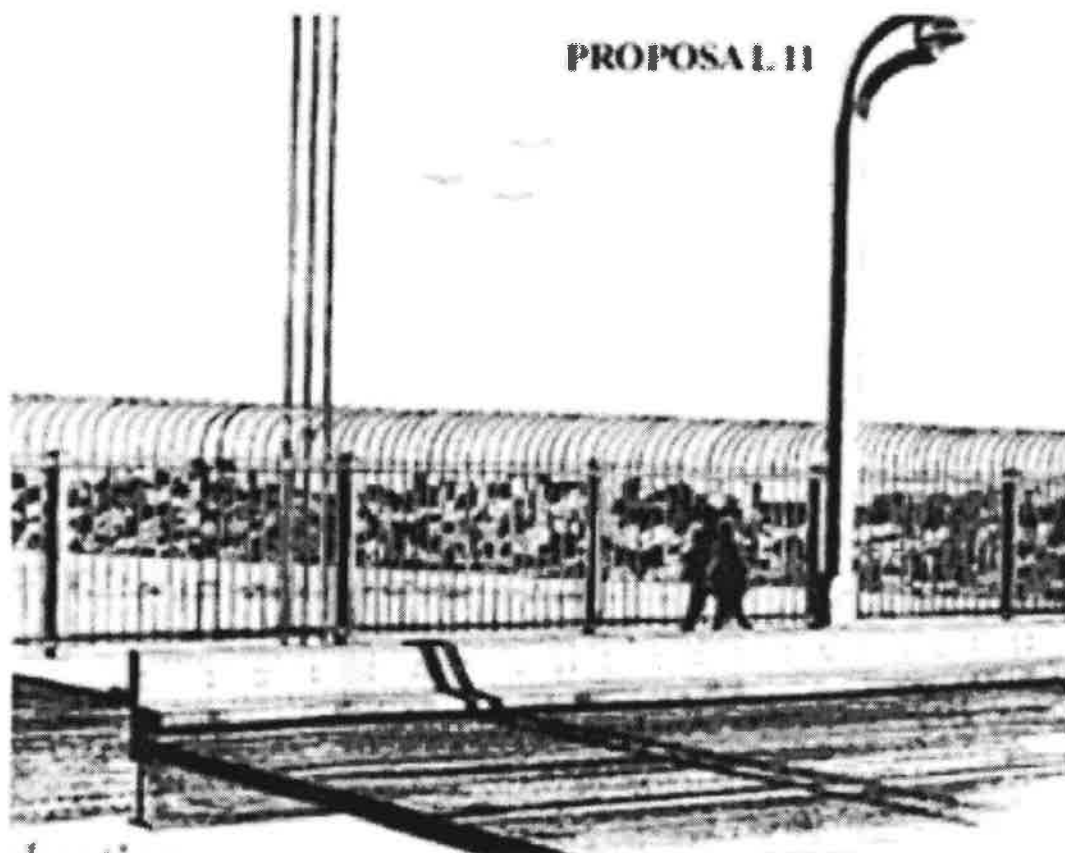

### *Evaluation:*

*A variation of this design was prototyped and deemed too easy to climb. Requires existing railing to be removed.*

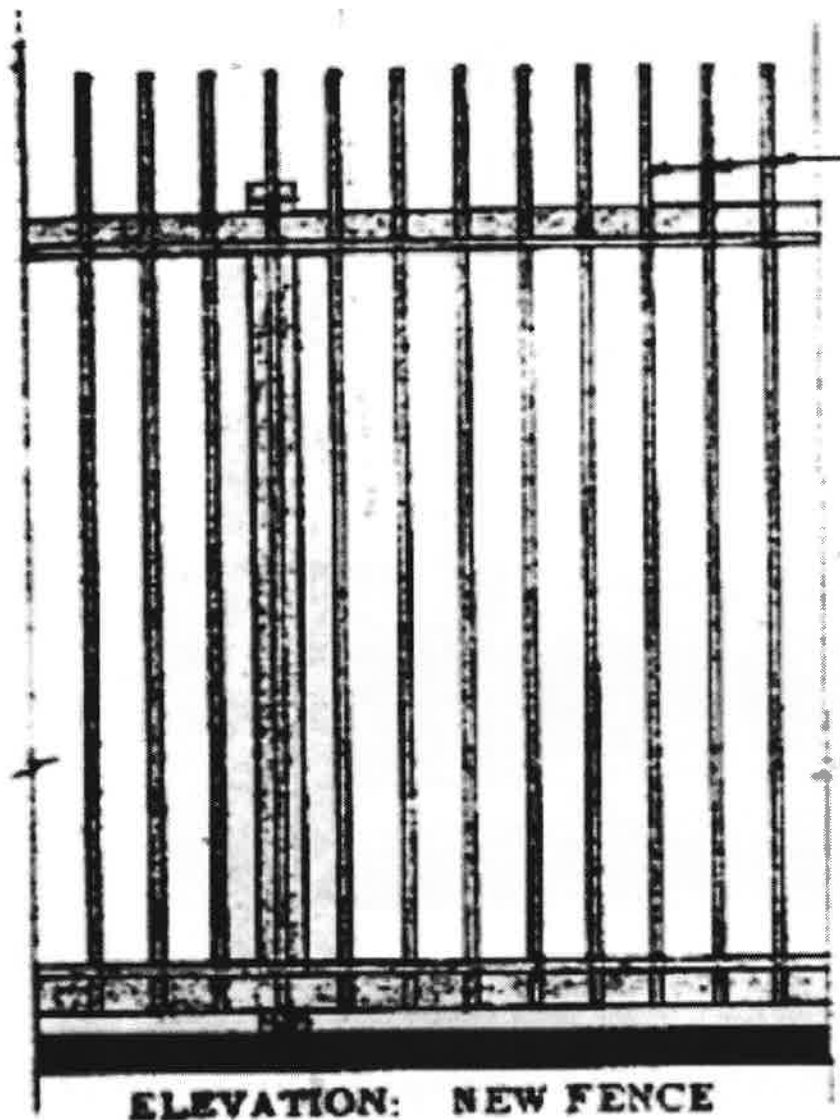

**ELEVATION: NEW FENCE**

**PICKETS**



**EXISTING RAIL**

## *6. Existing Prototype*



### *Design:*

*Eleven foot high fence with thin horizontal tensed steel wire connected with vertical Z-Clip fasteners at 4 foot intervals. Posts curved similar to light posts, thus making fence difficult to climb.*

## 6. Existing Prototype

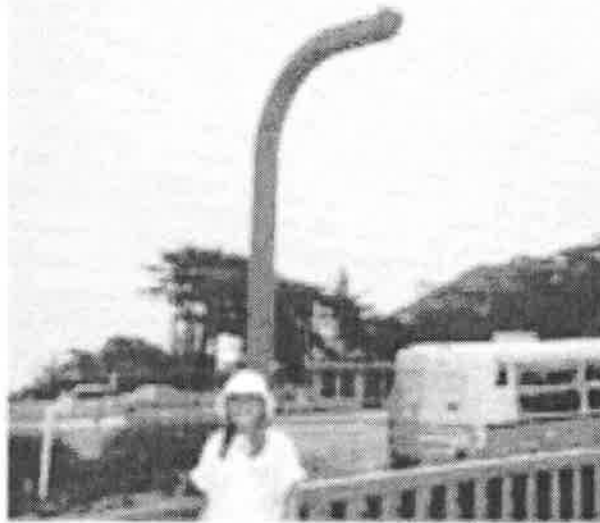

### *Advantages:*

- *Easy to install and maintain.*
- *Meets Anshen & Allen criteria.*
- *Nearly invisible from a distance.*
- *Difficult to climb.*
- *Maintains integrity of existing railing.*
- *Fence posts 100 feet apart.*



## *6. Existing Prototype*



### *Disadvantages:*

- *Pedestrians may feel "fenced-in" with the overhang and wire fence design.*

### *Evaluation:*

*Acceptable Alternative.*

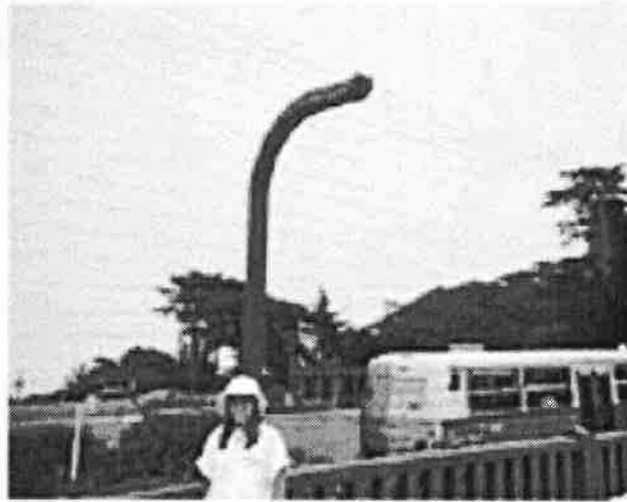

*Evaluation:  
Acceptable alternative.*

**2. Net**

*Outrigger to collapse and entrap jumper in net*

*Outrigger in collapsed position*

*Released suflex netting unravels and entraps jumper*

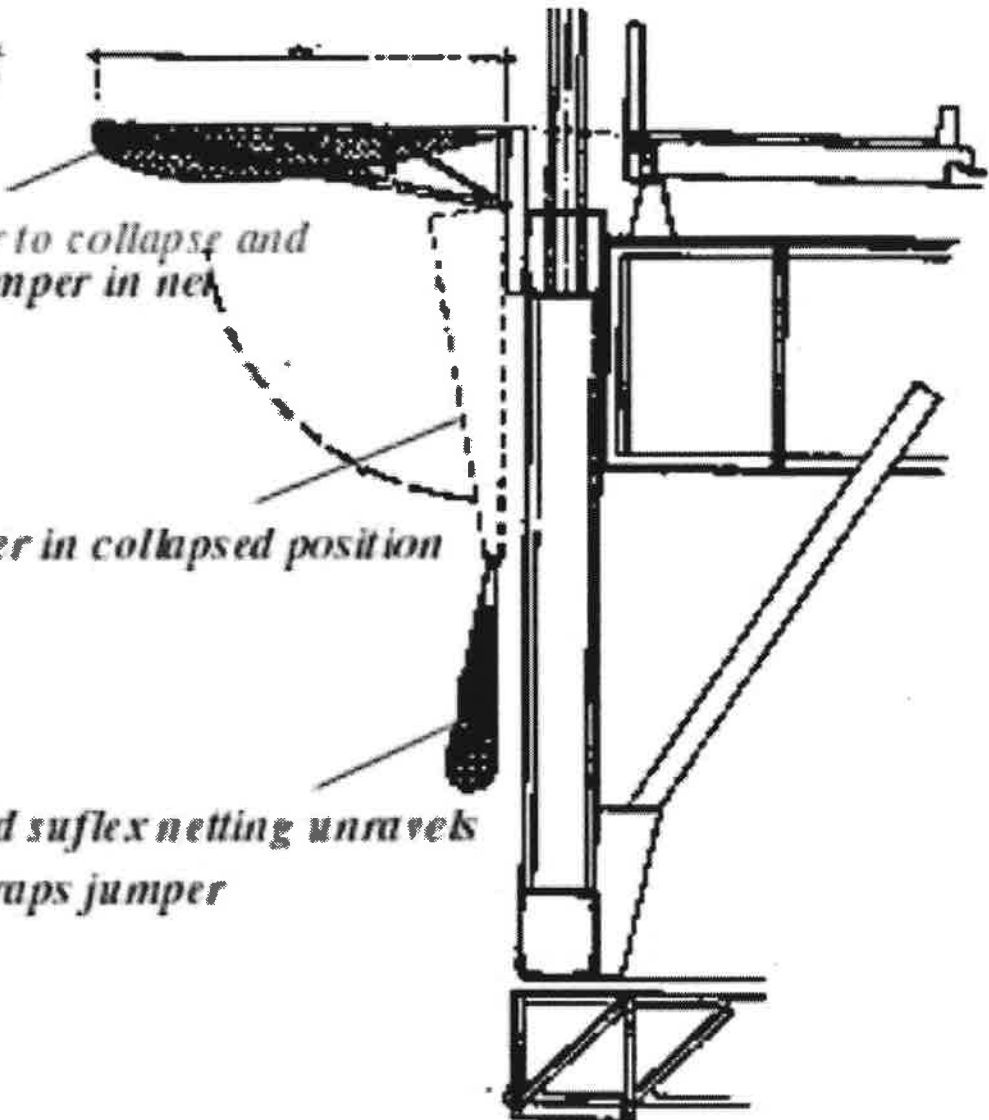

## *1. Net*

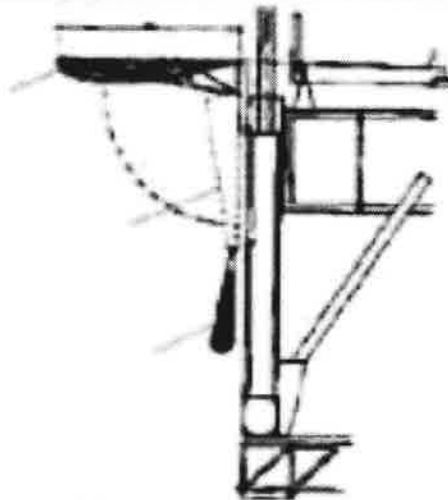

### *Design:*

*A series of semi-connected nets would overhang each side of the bridge about 15 feet out from just below the level of the sidewalk. As someone attempts to jump from the bridge the net would entrap them and keep them from falling further.*

### *Advantages:*

*The net and related superstructure would not be seen by people driving by on the bridge and would only be seen by pedestrians who look over the railing towards the bay below.*

## 2. Net

### *Disadvantages:*

- *The nets and superstructure would be seen when looking at the bridge from a distance*
- *The cost would be very expensive to construct, install and maintain.*
- *The visual silhouette from a distance would be impaired.*
- *It would be difficult to get someone out of the nets who is uncooperative*
- *May not meet wind resistance requirements.*
- *Would interfere with maintenance scaffold and operations.*
- *Likely to be injurious to jumper*
- *Creates an attractive nuisance*

### *Evaluation:*

*Not considered a viable option due to the numerous disadvantages.*

*3. Clifton Bridge  
England*

*Path of collapsing arm*

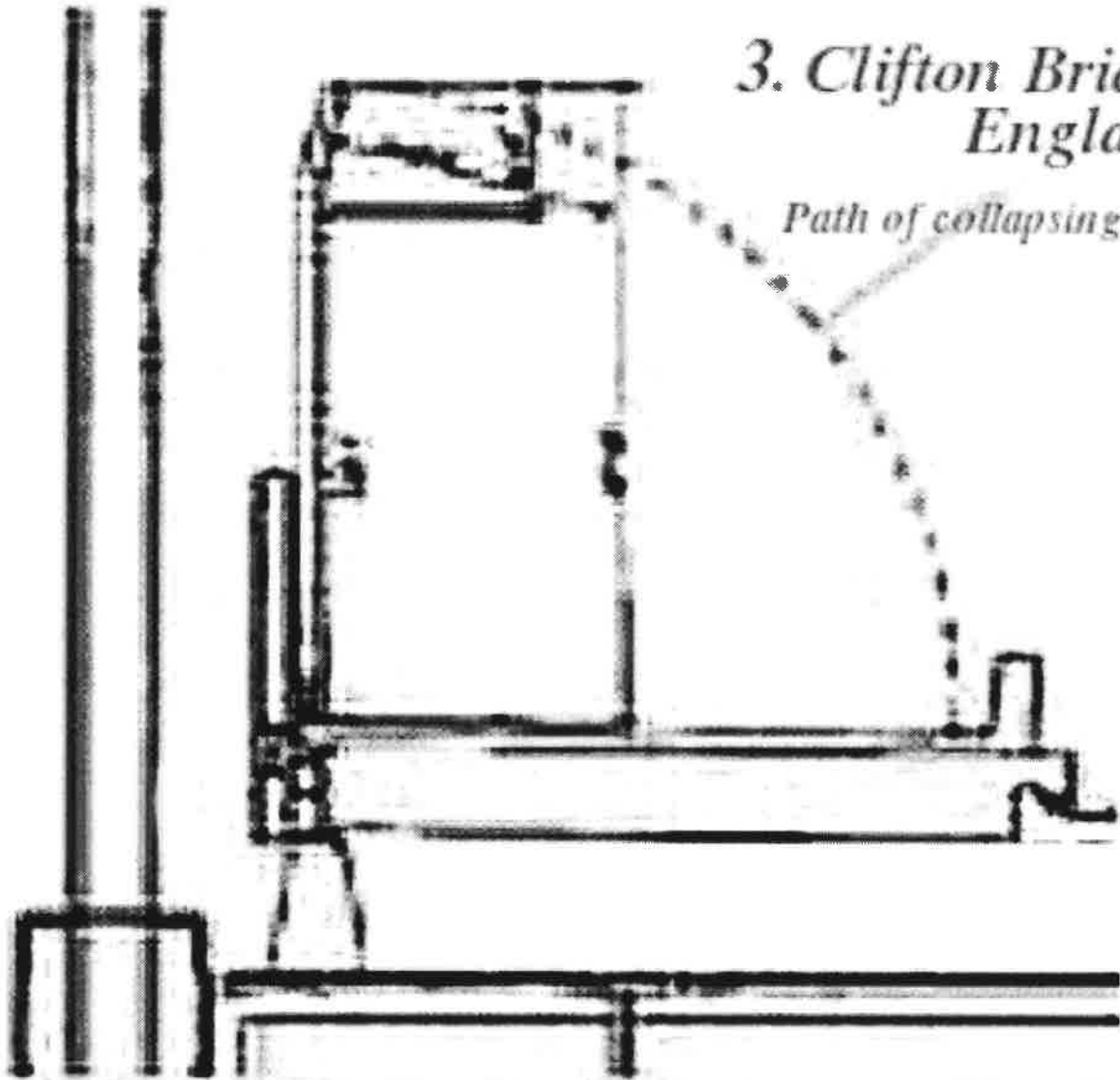

### *3. Clifton Bridge*

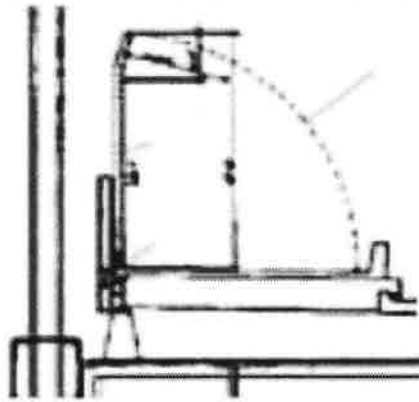

#### *Disadvantages:*

- *Far too easy to climb over*
- *Fence-like look*
- *May be hazardous to pedestrians at maintenance locations*
- *Unlikely to pass aerodynamic wind test*

#### *Evaluation:*

- *Not considered a viable option due to the major disadvantages*

#### *4. Z-Clip below railing*

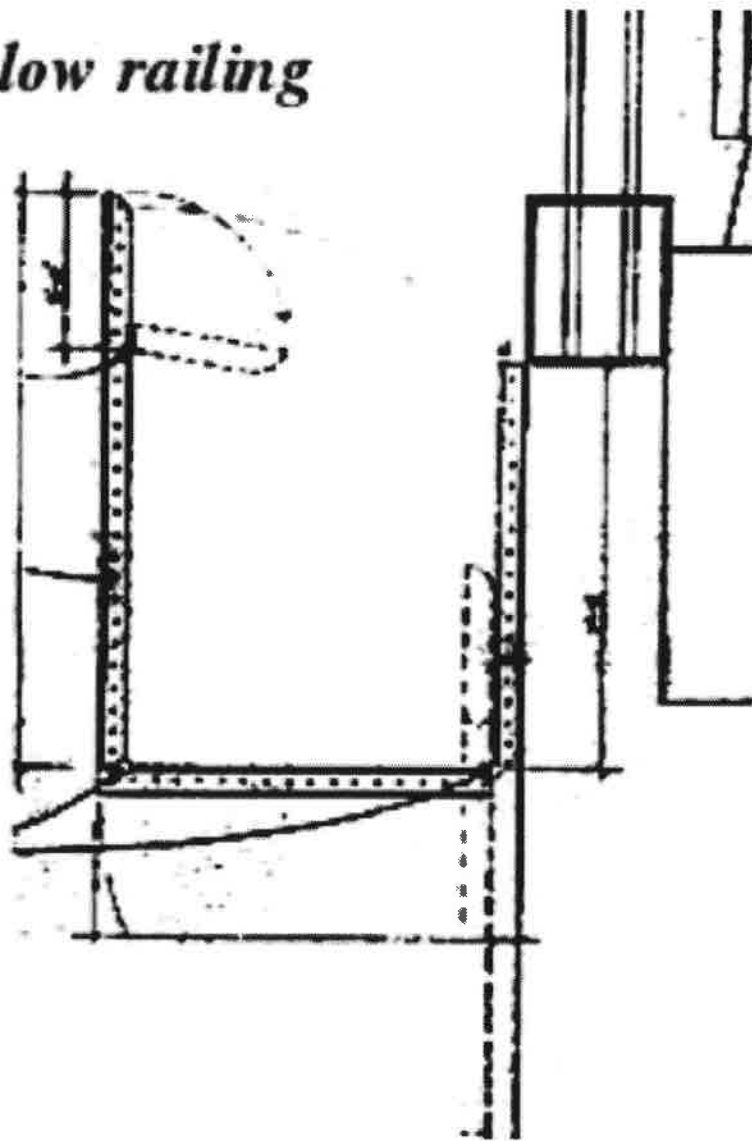



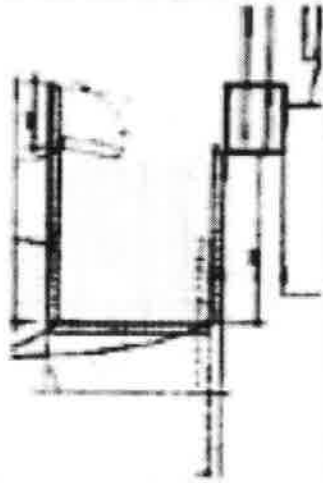

***Design:***

***Z-Clip or similar fence design located below the traveling scaffold, with hinges at every 100 foot or 200 foot section allowing the fence to fold down while the scaffold travels to its destination. The fence would have horizontal and vertical sections and also be hinged at the top of the fence to impede climber***

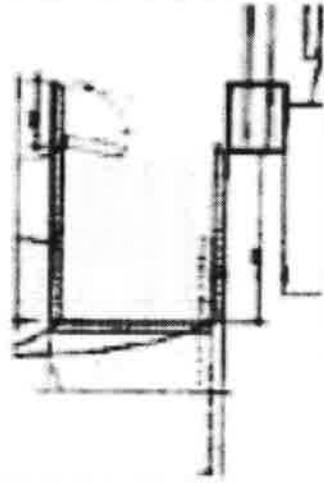

***Advantages:***

- *The fence or posts would not be seen by people driving by on the bridge and would only be seen by pedestrians who look over the railing towards the bay below.*
- *Difficult to climb*
- *Maintains integrity of existing railing*

## *4. Z-Clip Below Rail*

### *Disadvantages:*

- The fence posts would be seen by those looking at the bridge from a distance. The wires would be virtually invisible from a distance.*
- The maintenance aspect of the hinges allowing the structure to fold down would be difficult.*
- Moving the traveling scaffold and lowering and raising sections of the fence would be difficult and time consuming and greatly hamper maintenance.*
- Special netting or other fencing portions would have to be installed at a location where the traveling scaffold is resting or that specific section would be without a barrier.*
- Someone falling as a prankster may be hurt, particular if they fell on **on** a vertical post, thus litigation may be a concern (Attractive nuisance)*
- Difficult and hazardous for emergency response people.*

### *Evaluation:*

*Not considered a viable alternative due to the numerous disadvantages cited above.*

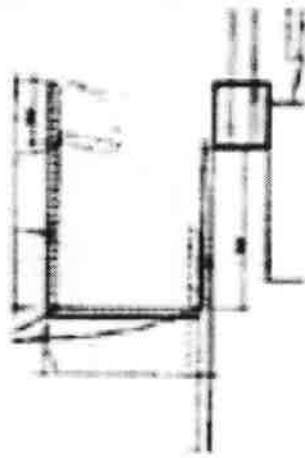

***Evaluation:***

*Not considered a viable alternative due to the numerous disadvantages cited.*

*5. Z-Clip away from rail*

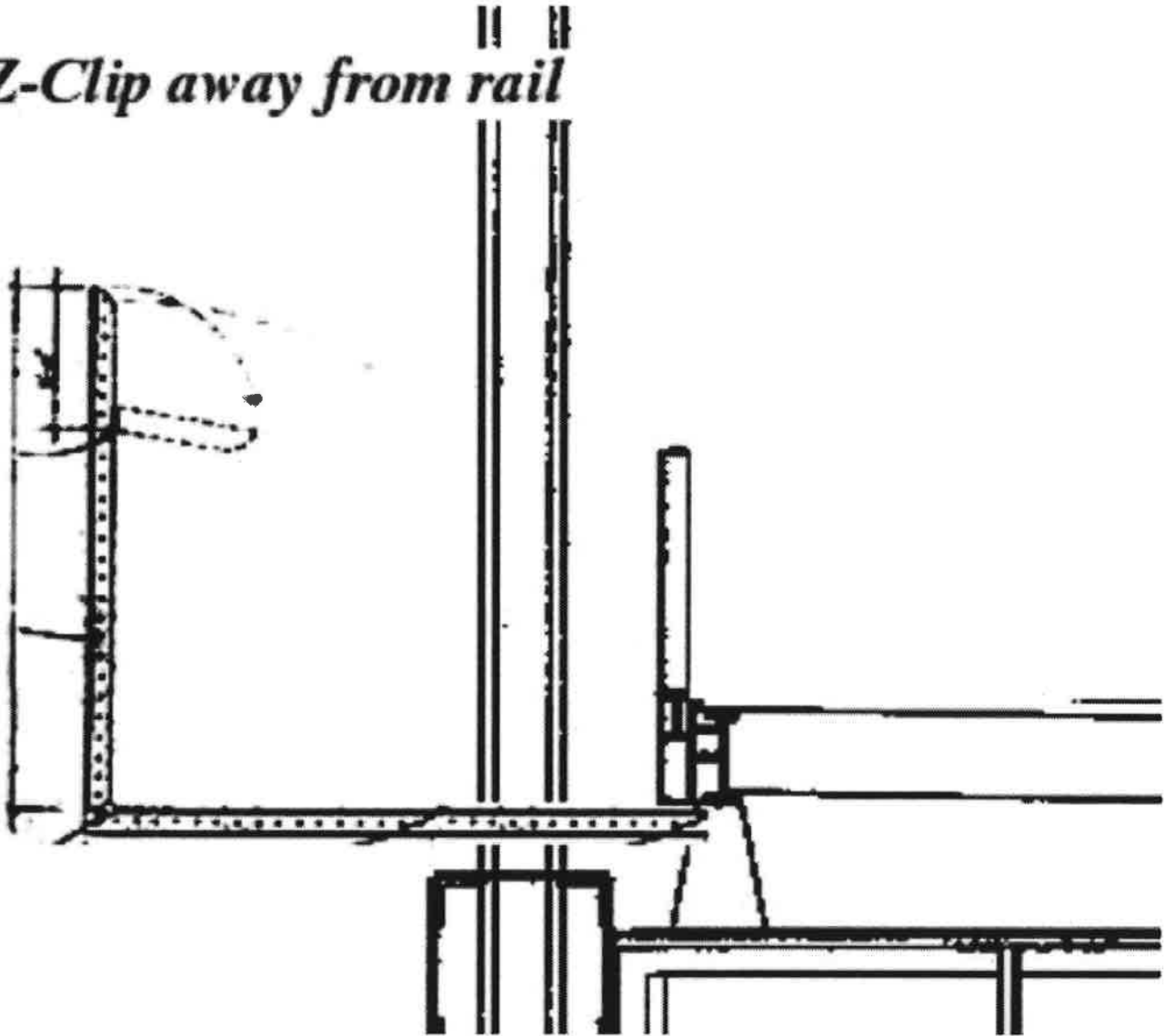

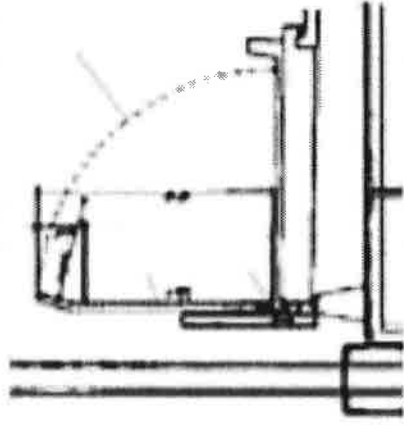

**Disadvantages:**

- *Far too easy to climb over*
- *Fence-like look*
- *May be hazardous to pedestrians at maintenance locations*
- *Unlikely to pass aerodynamic wind test*

**Evaluation:**

- *Not considered a viable option due to the major disadvantages*

4. Z-Clip below railing

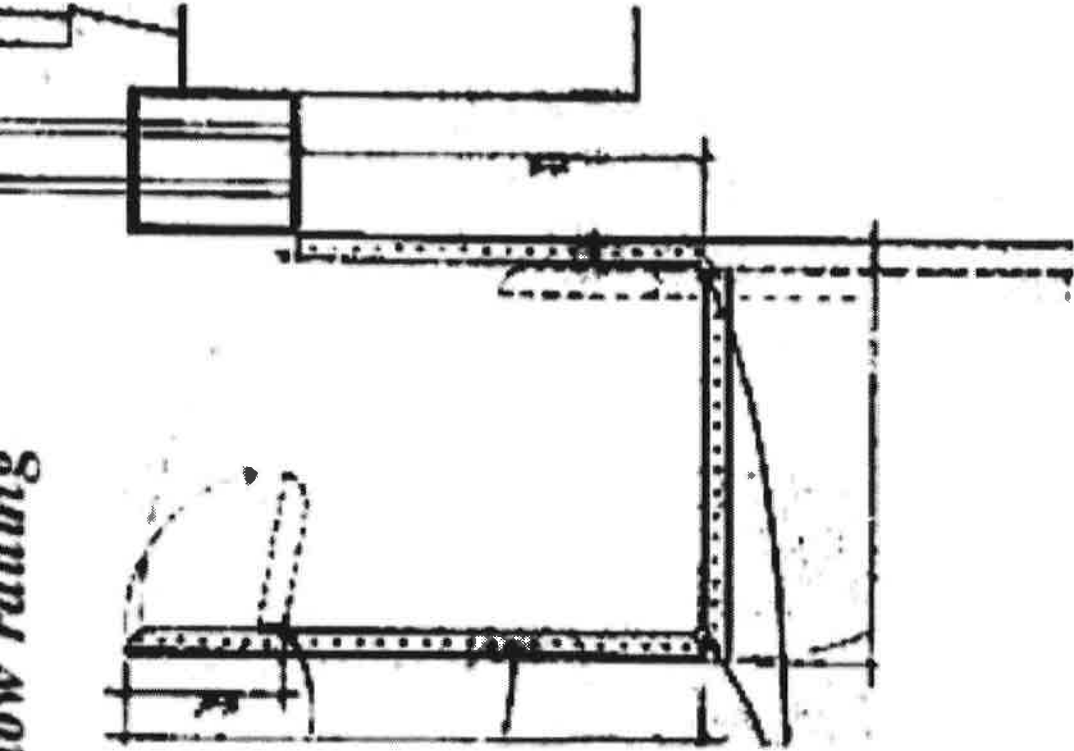

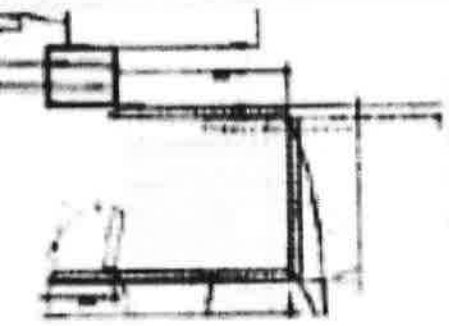

***Design:***

***Z-Clip or similar fence design located below the traveling scaffold, with hinges at every 100 foot or 200 foot section allowing the fence to fold down while the scaffold travels to its destination. The fence would have horizontal and vertical sections and also be hinged at the top of the fence to impede climber***



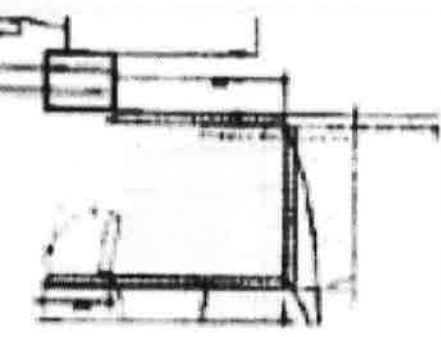

***Advantages:***

- *The fence or posts would not be seen by people driving by on the bridge and would only be seen by pedestrians who look over the railing towards the bay below.*
- *Difficult to climb*
- *Maintains integrity of existing railing*

##### *Disadvantages:*

- *The fence posts would be seen by those looking at the bridge from a distance. The wires would be virtually invisible from a distance.*
- *The maintenance aspect of the hinges allowing the structure to fold down would be difficult.*
- *Moving the traveling scaffold and lowering and raising sections of the fence would be difficult and time consuming and greatly hamper maintenance.*
- *Special netting or other fencing options would have to be installed at a location where the traveling scaffold is resting or that specific section would be without a barrier.*
- *Someone falling as a prankster may be hurt, particular if they fell on a vertical post, thus litigation may be a concern (Attractive nuisance)*
- *Difficult and hazardous for emergency response people.*

##### *Evaluation:*

*Not considered a viable alternative due to the numerous disadvantages cited above.*

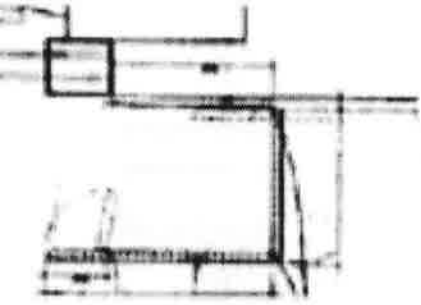

***Evaluation:***  
*Not considered a viable alternative due to the numerous disadvantages cited.*

*5. Z-Clip away from rail*

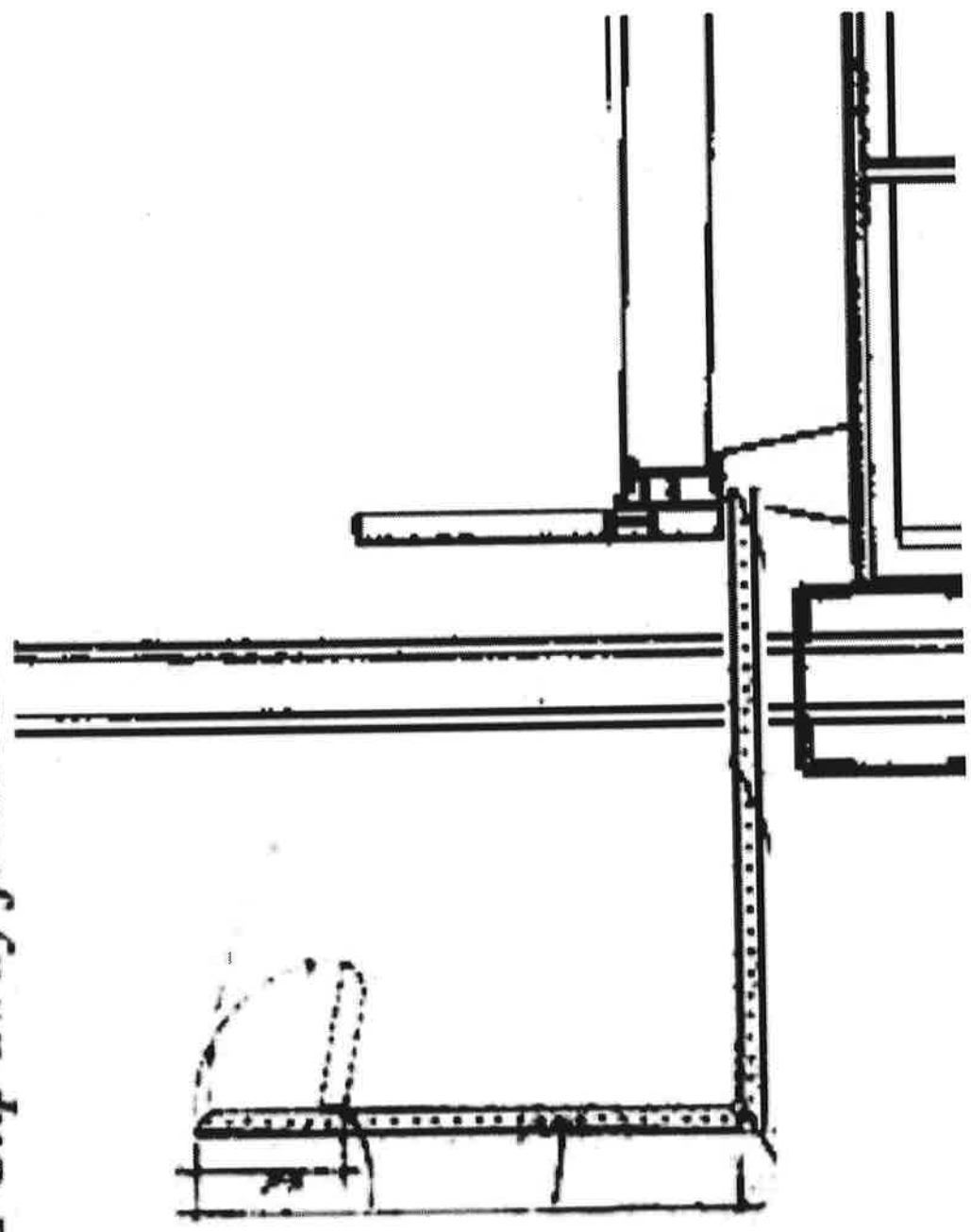

### 3: Z-Clip Below Rail

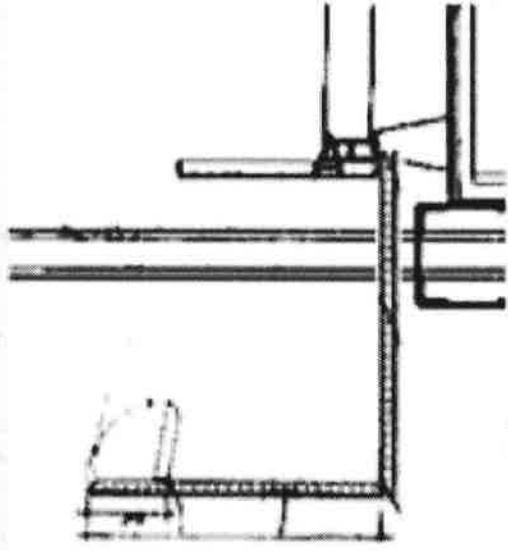

#### *Design:*

*Z-Clip or other similar designed fence placed horizontal above the traveling scaffold (about 1 foot below the sidewalk) and then curving vertically a short distance away from the railing (8-12 feet), with a hinged post at the top, thus making it more difficult to climb over.*

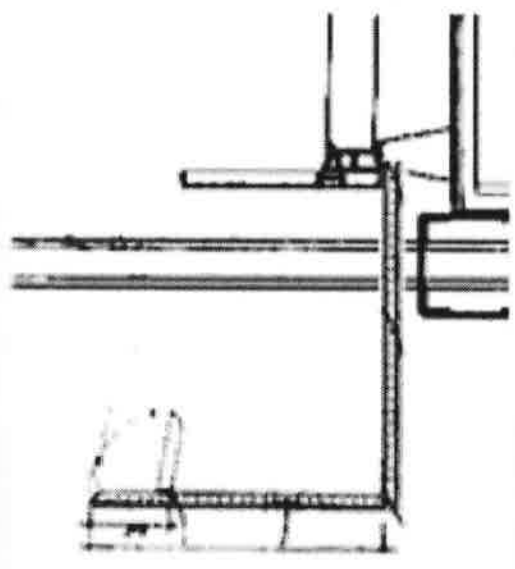

**Advantages:**

- *The fence would be away from the railing and pedestrians would not feel enclosed by a fence structure with an overhang.*
- *The fence would not seem as high or imposing, even though the horizontal portion would still be about 9 feet high, measured from below the railing.*
- *Difficult to climb.*
- *Meets the Anshen and Allen criteria.*
- *Maintains integrity of existing railing.*

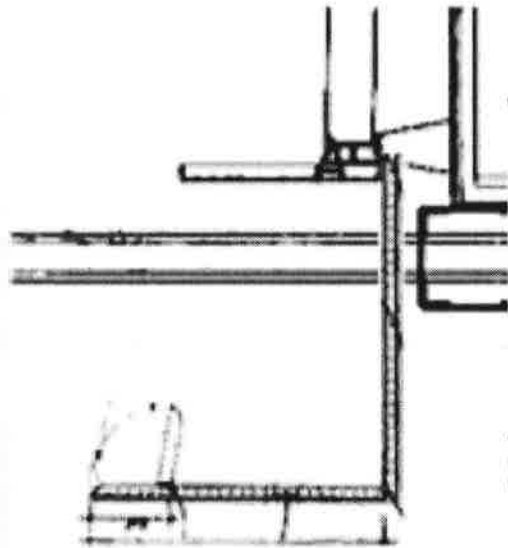

**Disadvantages:**

- *The fence posts would be seen from roadway, sidewalk and at the bridge from a distance. The wires would be virtually invisible from a distance.*
- *The traveling scaffold platform would have to be modified to travel under the horizontal portion of the fence with access every 100 feet through trap doors.*
- *High cost to construct.*
- *Attractive Nuisance.*
- *Difficult and dangerous for emergency response personnel.*

3. L-Clip away from rail

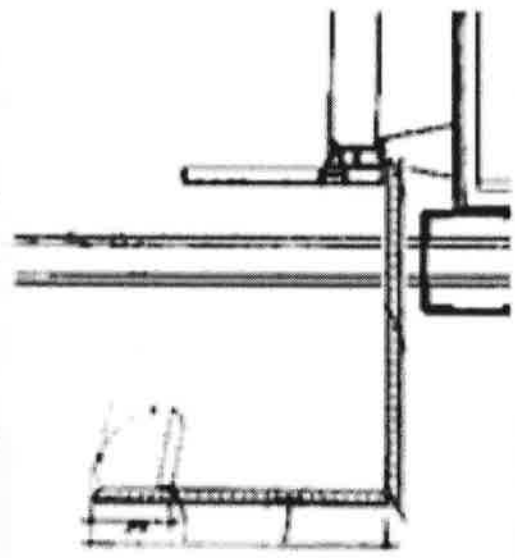

**Evaluation:**

*Not a viable option with noted disadvantages.*



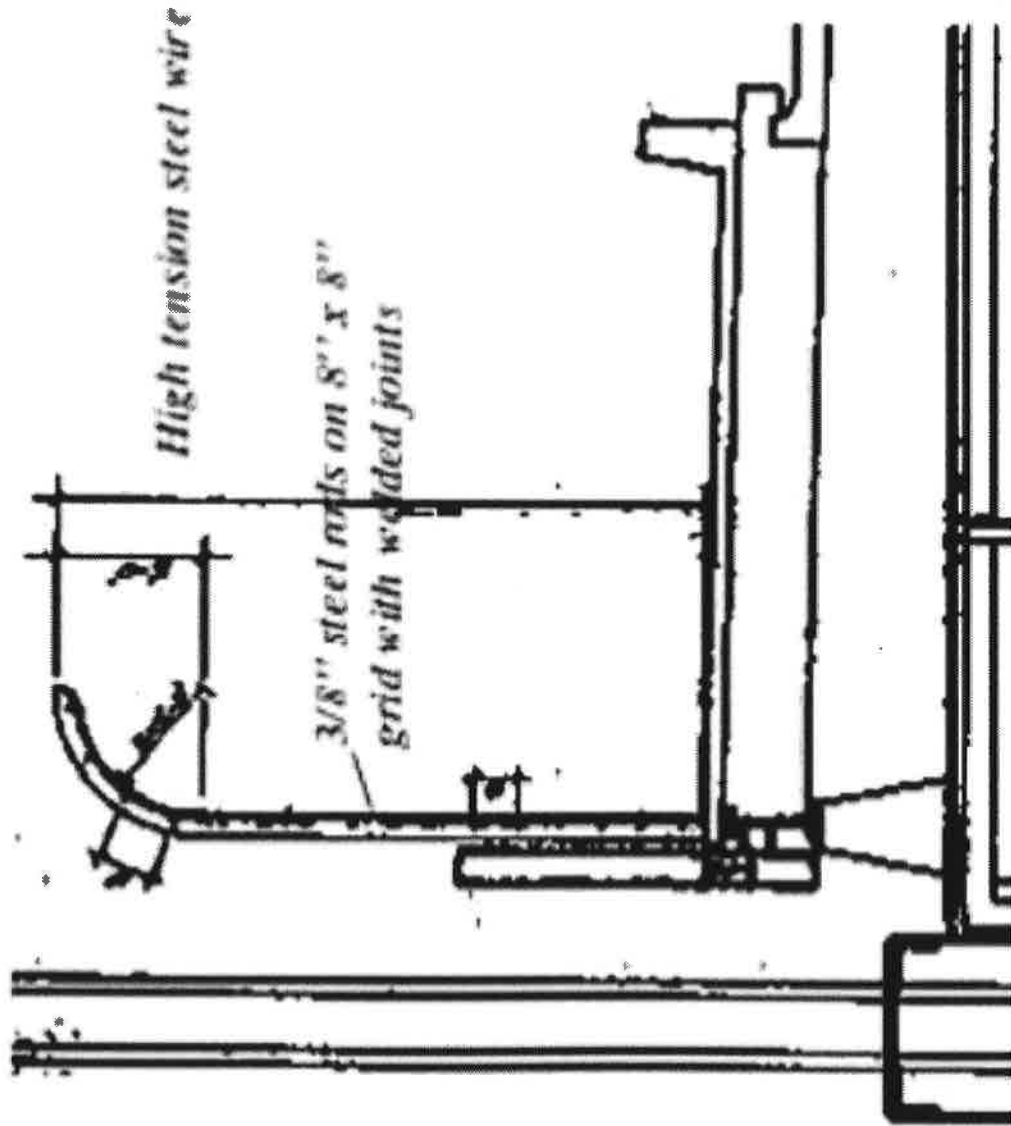

## *U. Eiffel Tower Modified*

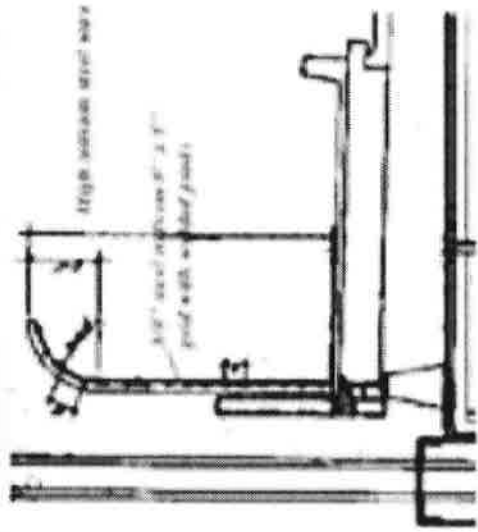

### *Design:*

*Eleven foot high fence with 3/8" steel rods on 8" x 8" grid, welded joints and curved at the top to mirror the light post design (similar to the Eiffel Tower barrier).*

### *Advantages:*

- *Meets the Anshen and Allen criteria.*
- *Difficult to climb.*
- *Maintains integrity of existing railing.*
- *Proven design.*

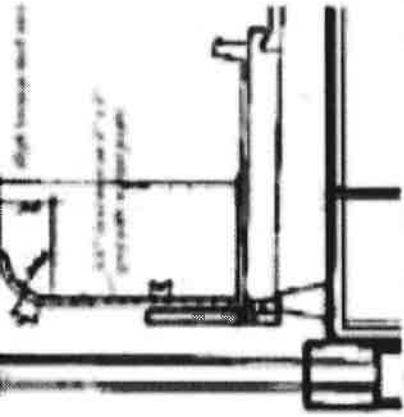

***Advantages:***

- ***Meets the Anshen and Allen criteria.***
- ***Difficult to climb.***
- ***Maintains integrity of existing railing.***
- ***Proven design.***

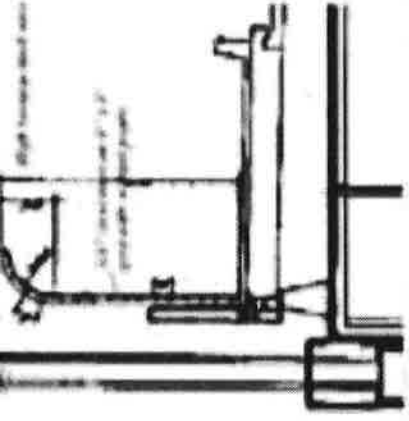

**Disadvantages:**

- *May not be aesthetically pleasing to look at because it looks like a thick wire grid fence and makes pedestrians feel fenced-in with overhang as they walk along the sidewalk.*
- *Very costly to construct and install*

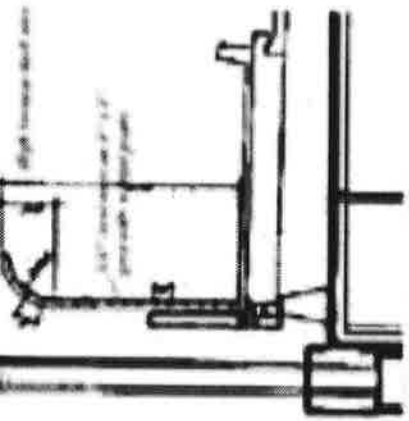

***Evaluation:***

***Acceptable alternative if widening aerodynamics med criteria.***

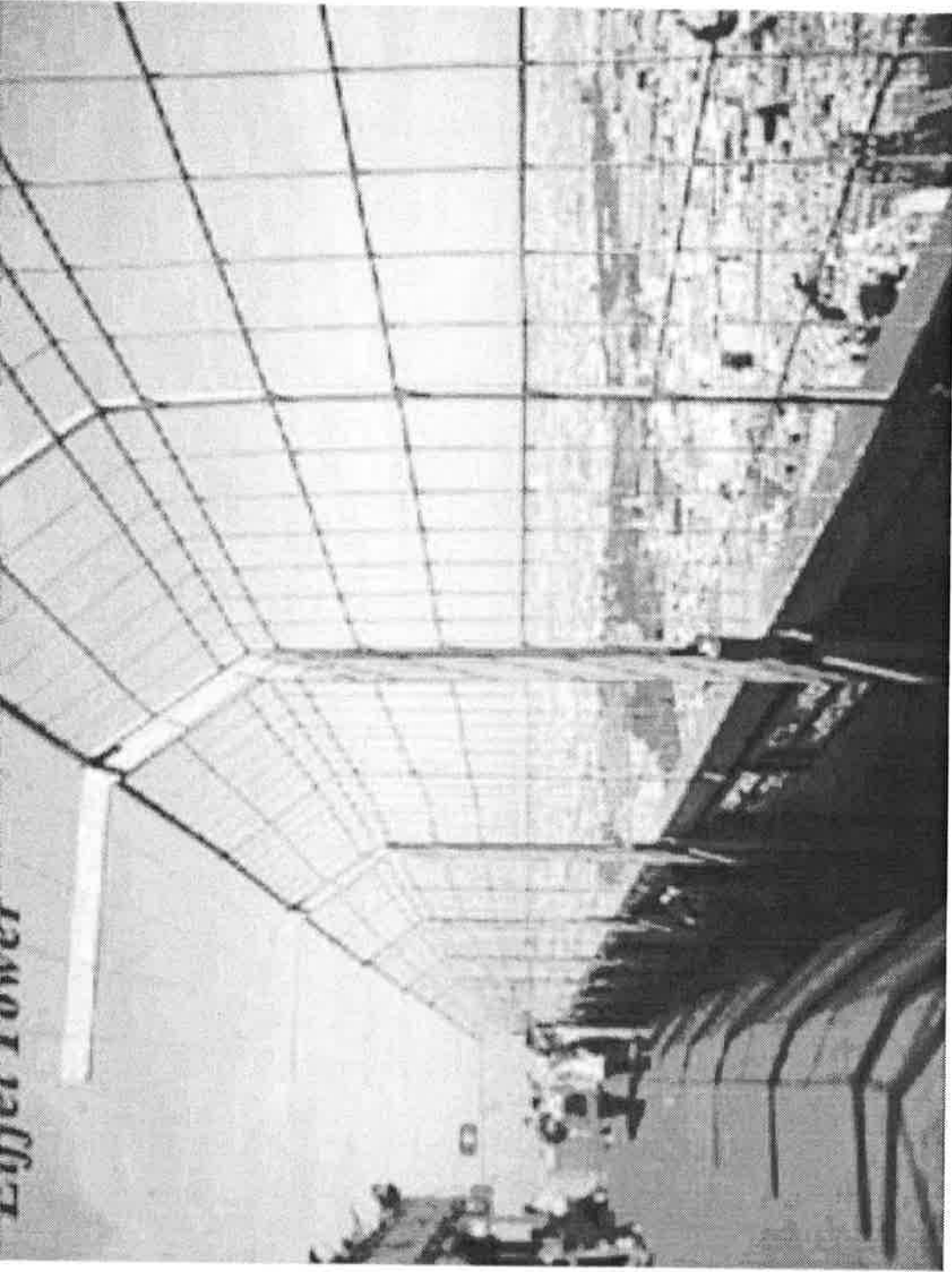

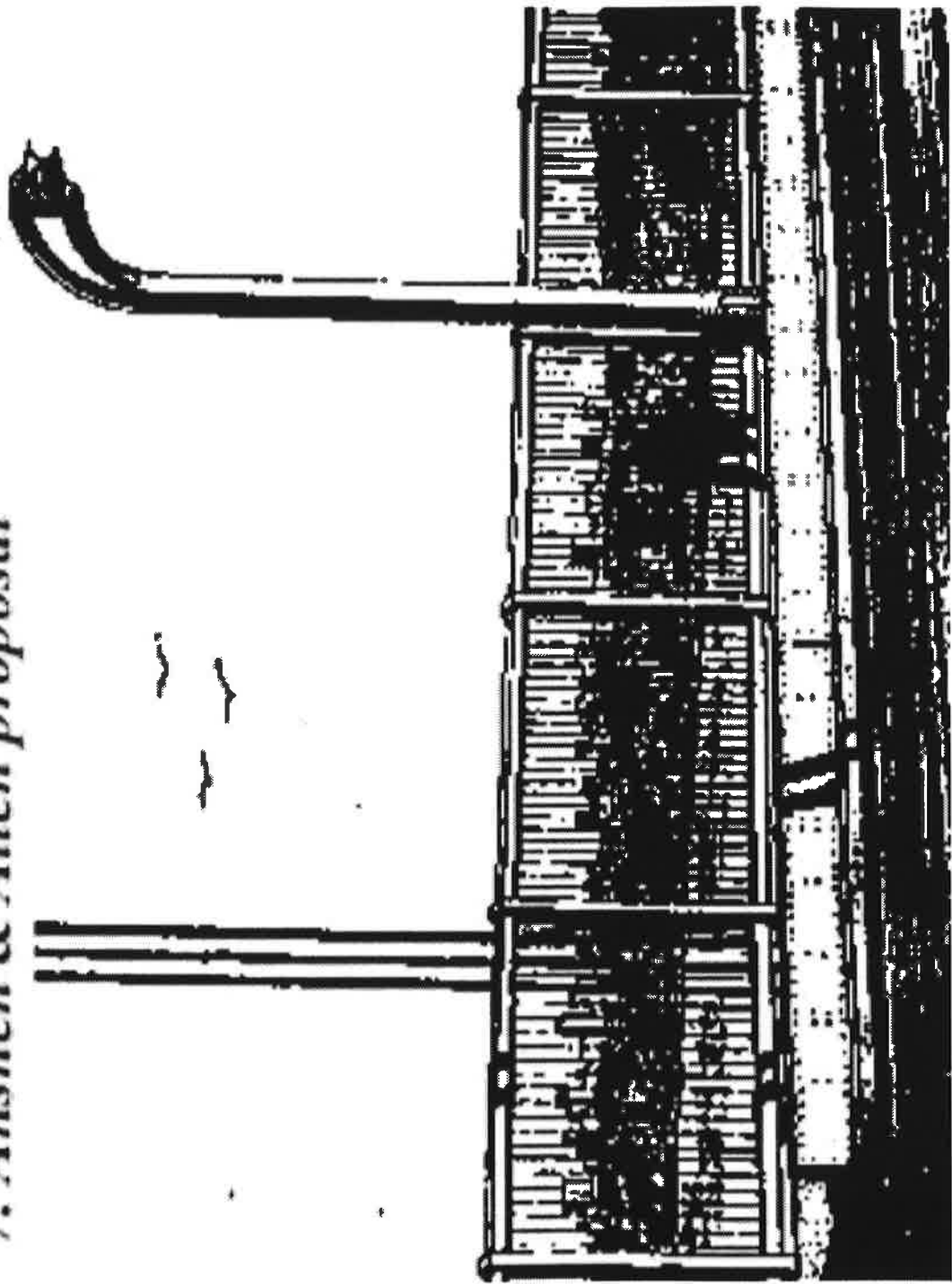

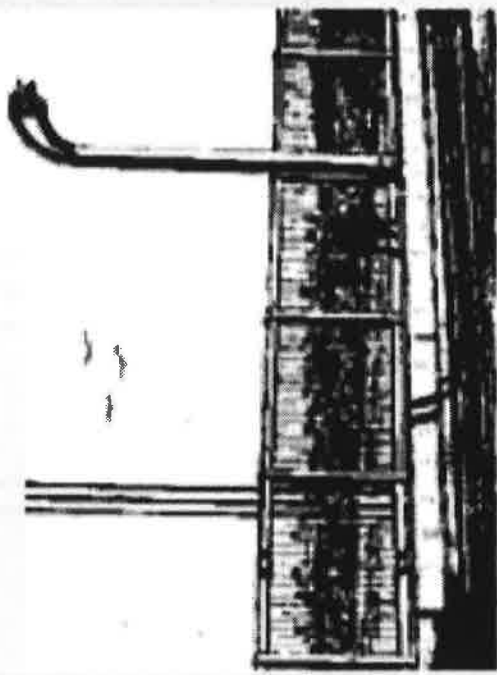

***Design:***

*Anshen and Allen proposed barrier from the 1971 study. Replacing the existing railing with picket type round rods of approximately one inch in diameter.*

***Advantages:***

- Proven design found on highway overpasses and elsewhere.*
- Meets the Anshen and Allen criteria.*



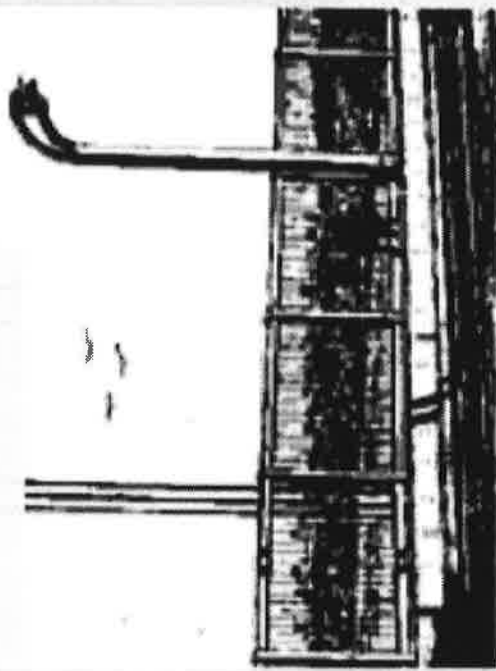

***Disadvantages:***

- *Changes the architectural integrity of the Bridge by replacing the existing railing.*
- *Very costly to build, replace and install*
- *Not difficult to climb over.*
- *Not as invisible as other alternatives.*

***Evaluation:***

*This design was prototyped and found too easy to climb over.*

*High tension steel wires  
on collapsible section*

*Top 2'0" when grabbed will fall  
inwards 1'10" over pedestrian  
sidewalk*

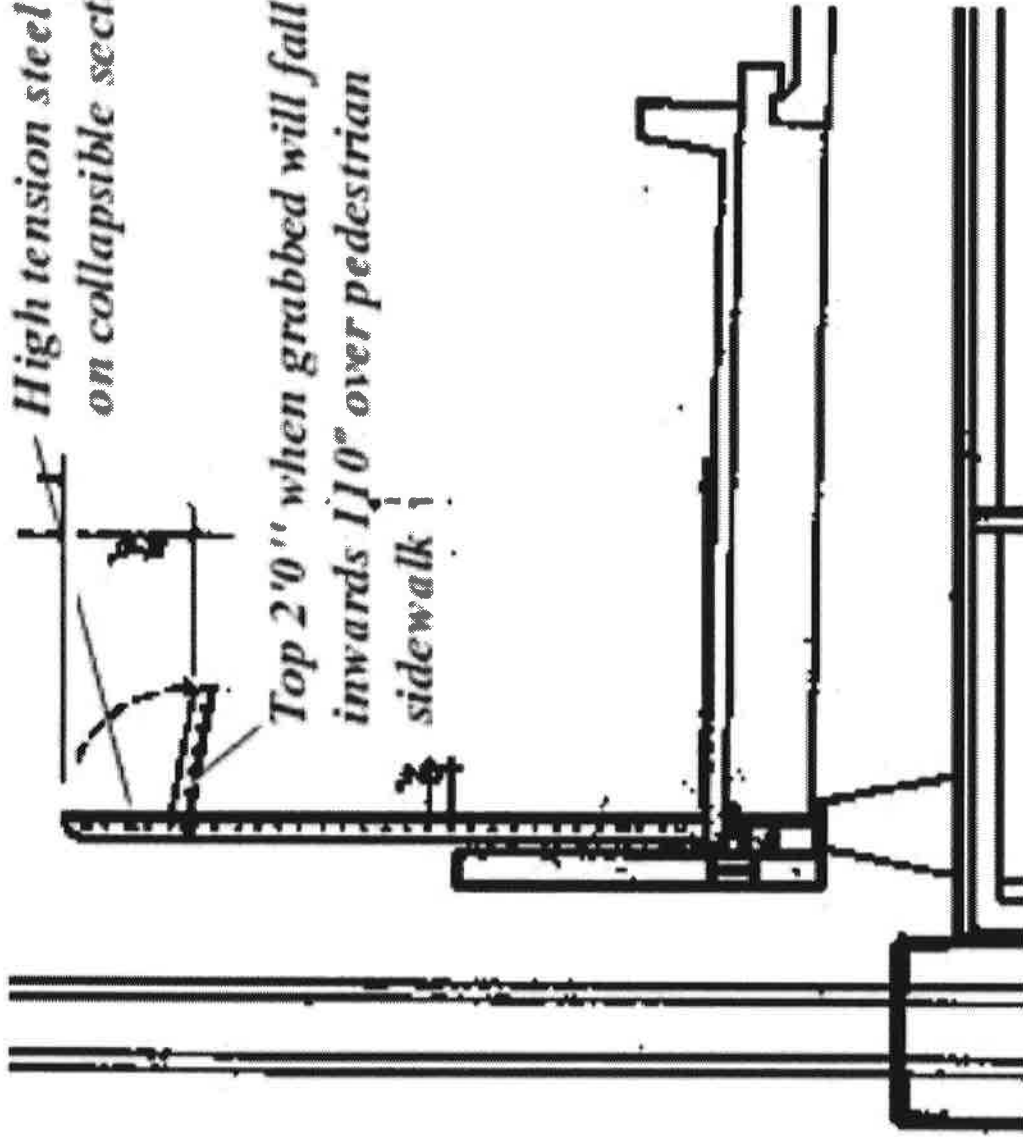

8. High Tension Wires with Hinge Post

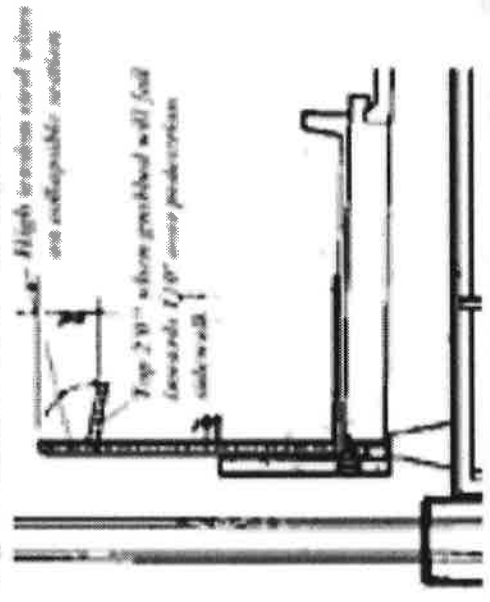

High tensile stainless steel gauge wire fence placed on the top of existing railing with two inch round straight hinged posts located at every other suspension cable, 100 feet apart. Vertical wires would be located at four foot intervals and connected by special fasteners.

8. High Tension Wires with Hinge Post

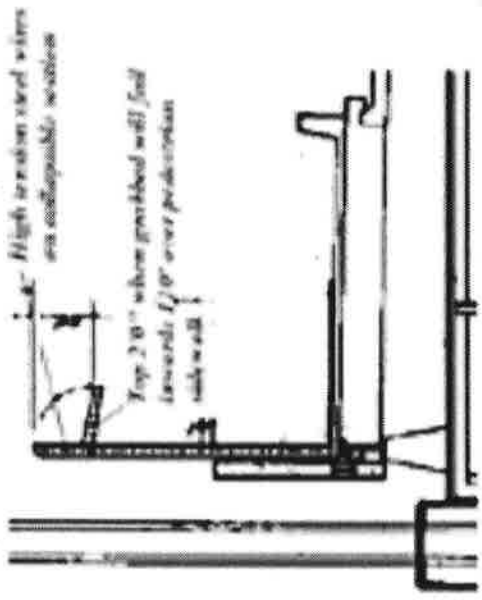

*Advantages.*

- *Meets Anshen and Allen criteria.*
- *Nearly invisible for motorists crossing the bridge and anyone looking from a distance, with fence posts obscured by suspension cables.*
- *Difficult to climb over due to spring type hinge pulling back on timber.*
- *Least expensive alternative.*
- *Easy to install and maintain.*

8. High Tension Wires with Hinge Post

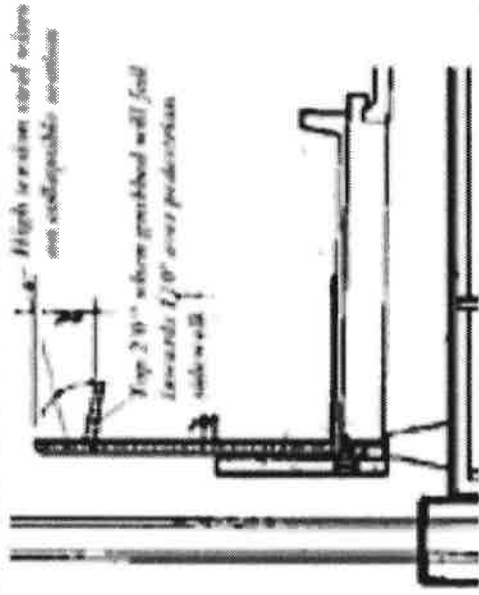

**Disadvantages:**

- Pedestrians may get the 'fenced-in' feeling.
- Looks like a wire fence.
- Maintenance gates would be through existing railing or at refuge bays.

**Evaluation:**

Acceptable and least costly alternative.

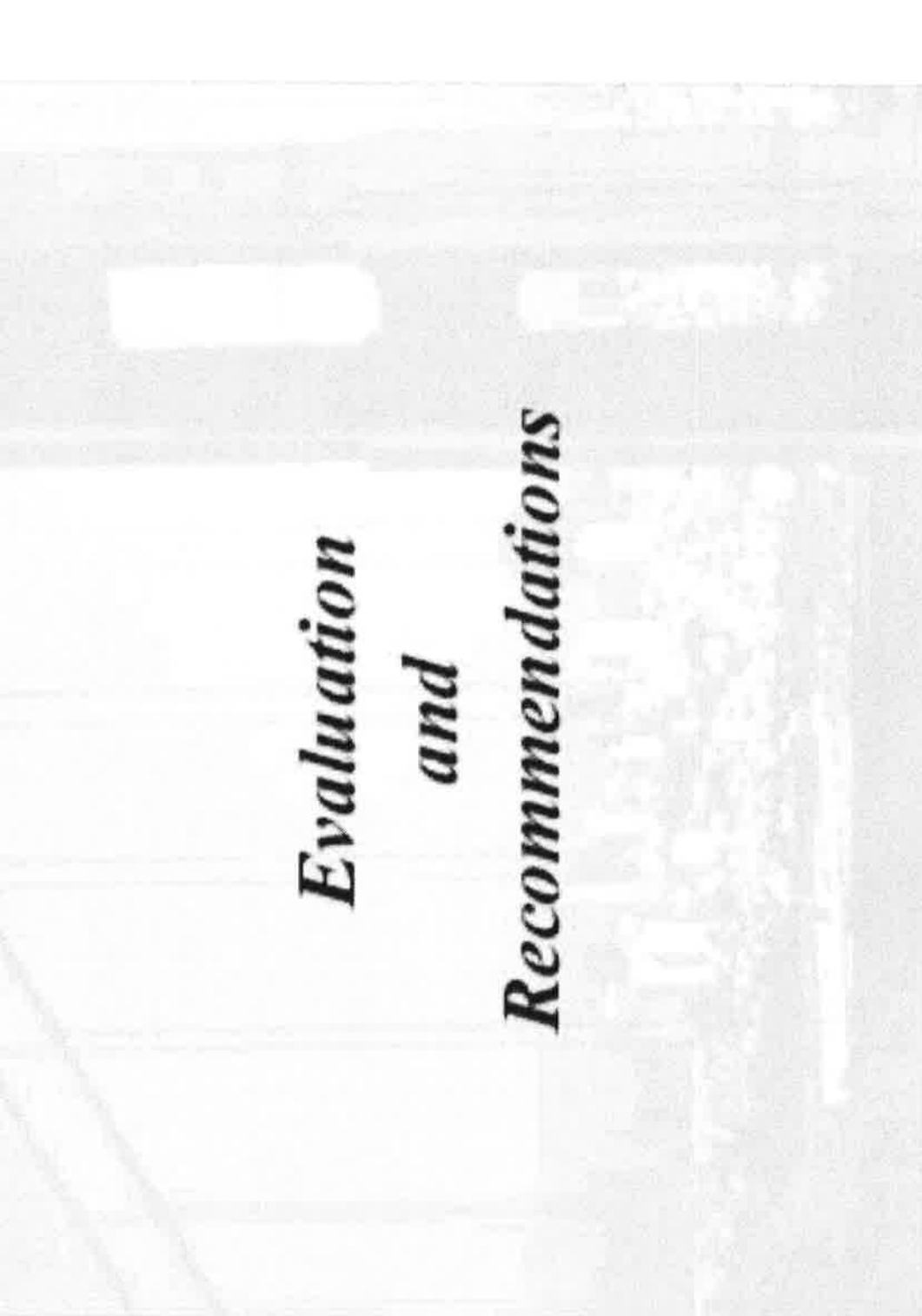

*Evaluation  
and  
Recommendations*









